

HVAC Equipment	Wiring Hub Solution	Wired Solution	Airflow Control	Fresh Air Control	ERV/HRV Control	Whole House Fan Control	Economizer Control	Humidity Control	WiFi Option
GE, HP or DFHP 3H/2C	●		●				●		

For Wiring Airflow Control Components, See Submittal / Wiring Document - AOR, Airflow Control, C365C42 and WH42

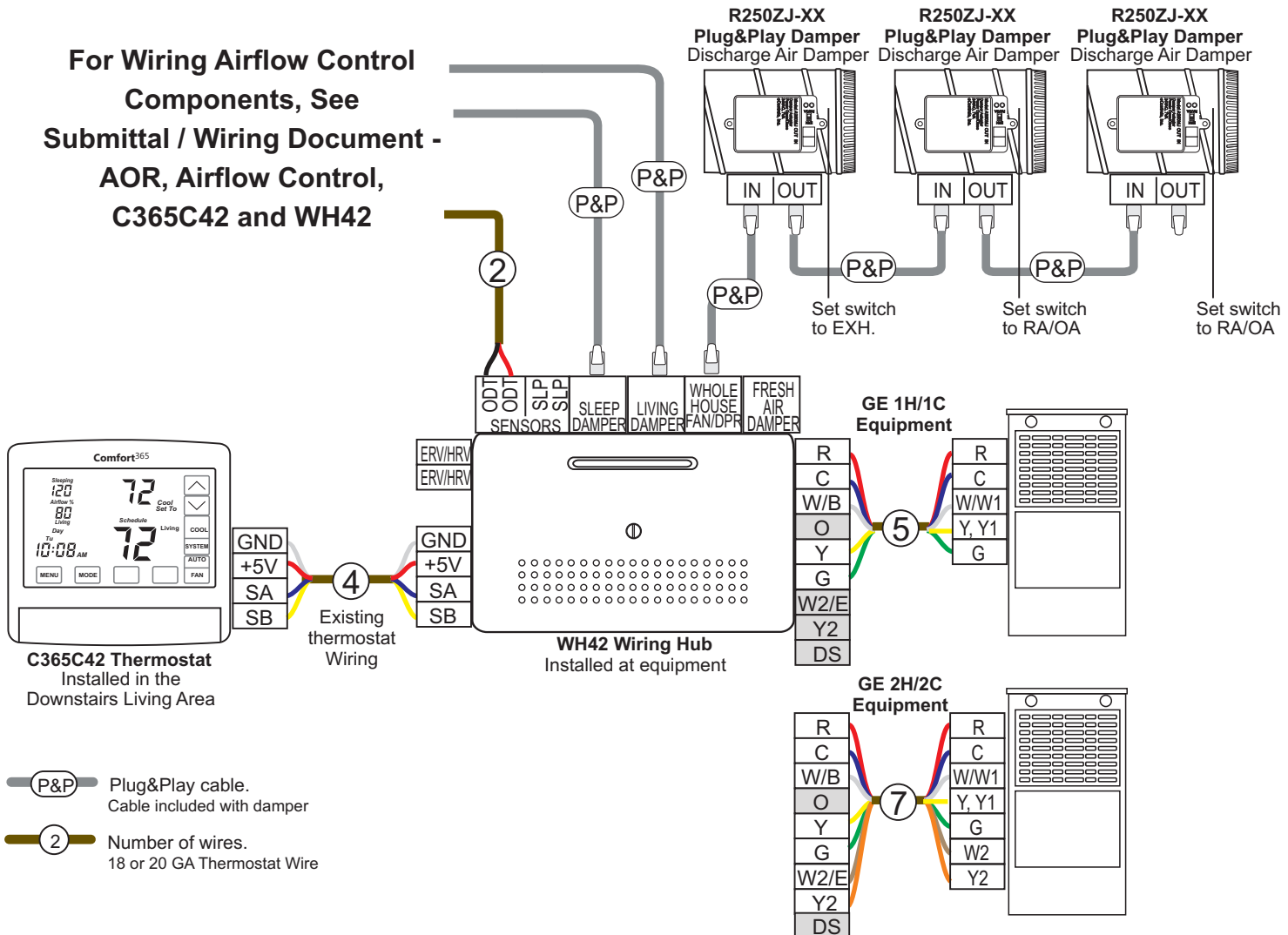

Installation

Model #	Description	Quantity
C365C42	Comfort365 Communicating Thermostat.	1
WH42	Wiring Hub	1
For Airflow Control Dampers and Sensors, See Submittal / Wiring Document - AOR, Airflow Control, C365C42 and WH42		
R250ZJ-	Round Plenum Damper with Plug & Play Connection. ____ inch Diameter	3
TS3	Required for DFHP.	

Project Information

Date:	Job Name:	PO #:
Location:	Architect:	
Engineer:	Contractor:	
Buyer:	Notes:	