

## Description

The C365 thermostat controls the heating and cooling system the same as most programmable thermostats. It also controls the airflow to the upstairs and downstairs using an upstairs and a downstairs modulating damper. A temperature sensor located upstairs monitors the upstairs temperature and the temperature sensor in the C365 monitors the downstairs temperature.

The C365 adjusts the upstairs and downstairs airflow during heating and cooling calls to maintain uniform upstairs and downstairs temperatures.

## System Modes

Off, Heating only, Cooling only, Automatic Heating or Cooling. And Emergency Heat (EHeat) when used with heat pumps.

## Fan Modes

Continuous or Automatic fan operation.

## Thermostat Modes

Hold, Schedule or Vacant mode.

## Programs per Day

Morning, Daytime, Evening and Night.

## Program Format

Weekdays and weekend— 5/2.

## Temperature Override

Up/down keys adjust the setpoint temperature. Temperature setting is held for 4 hours when adjusted in Schedule mode.

## Airflow Control

Airflow control can be turned off using Option 18. Dampers fully open and airflow is no longer displayed on the thermostat.

## Airflow Override

Up/down keys adjust the upstairs/downstairs airflow. Airflow setting is held for 4 hours when adjusted in Automatic mode.

## Airflow Limits

Maximum upstairs and downstairs, heating and cooling airflow limits are set during installation.

## Nighttime Operation

Option used when bedrooms are located upstairs. C365 uses the upstairs temperature sensor to control heating and cooling calls and directs more airflow upstairs.

## Compatible Wiring Hub /HVAC Equipment

Compatible with wiring hub WH11 for gas/electric equipment with 1-stage heating and 1-stage cooling. Or, wiring hub WH32 for gas/electric equipment, conventional or dual fuel heat pumps with 3-stage heating and 2-stage cooling.

## Upstairs Temperature Sensor

One Model TS510W or two Model TS520W upstairs temperature sensors can be used and are wired to Wiring Hub. Or, use one or two Model TS5WL wireless temperature sensors. Wireless sensors require the ER1 radio module installed in the Wiring Hub.

## Modulating Dampers

Round or rectangular dampers using Model A80MJ plug and play, modulating actuators, plug into to the Wiring Hub.

## Power

Operates on 24VAC from the HVAC equipment to the Wiring Hub R and C terminals.

## Warranty

This thermostat is warranted to be free of defects due to workmanship or materials under normal use and service for a period of 5 years from date of installation and not longer than 6 years from manufacturing date code.

## SEPARATE THE C365 SUBBASE

Place a slotted screwdriver in the slots as shown and rotate to remove subbase from the C365 housing.

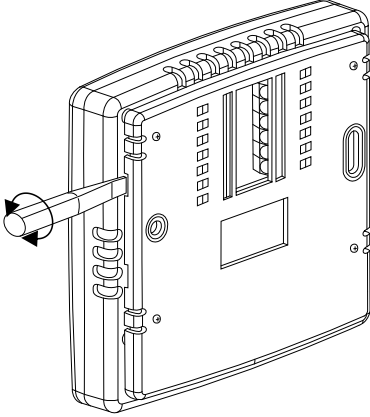

## ATTACH THE SUBBASE TO THE WALL

Attach the subbase to an interior wall and about 5-feet above the floor as shown using the screws and wall anchors supplied. The wiring to the HVAC equipment passes through the opening next to the terminals.

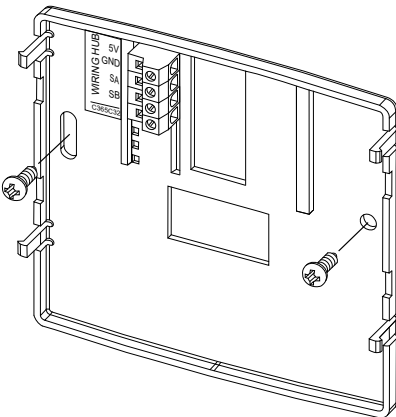

## INSTALL TWO AA BATTERIES

The batteries power the clock when 24VAC power is lost. Slide the battery cover downward and install the two AA batteries as shown.

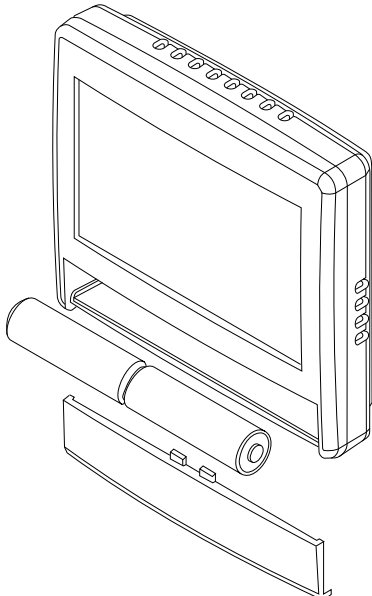

## INSTALL UPSTAIRS & DOWNSTAIRS DAMPERS

Refer to the WH11 or WH32 Wiring Hub Installation manual for instructions on wiring dampers to the wiring hub.

Install an R80CJ damper in the duct supplying air to the upstairs. Install a second R80CJ damper in the duct supplying air to the downstairs. Each damper uses 2.4VA of power.

When two or more dampers are required to define the upstairs or downstairs zones, the second damper may be plugged into the connector marked OUT on the first damper. LEDs on the damper actuator indicate when the damper is fully open (green) or fully closed (red).

**!** Ensure that damper installation does not cause obstruction to the damper blade.

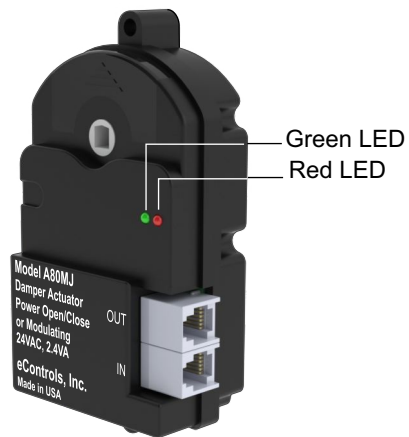

## INSTALL UPSTAIRS TEMPERATURE SENSOR

Refer to the WH11 or WH32 Wiring Hub Installation manual for instructions on wiring upstairs temperature sensors to the wiring hub or connecting wireless sensors to the wiring hub.

**Wired Sensors:** One or two wired temperature sensors can be installed and the temperatures are averaged. Model TS510W is used for single sensor installations. Model TS520W is used for dual sensor installations.

**Wireless Sensors:** One or two wireless temperature sensors can be installed and the temperatures are averaged. Wireless sensors require Model ELR1 plug in radio module. The radio module plugs into the WH11 or WH32 wiring hub.

## WIRING INSTRUCTIONS

### Warning!

Turn the power to the HVAC equipment off before wiring.

### Wiring Thermostat to Wiring Hub

Use 5-conductor(1 spare), 18 or 20 gage, thermostat cable.

C365 Terminal	Wire Color	Wiring Hub Terminal	Function
5V	Red	5V	24VAC Power
GND	White	GND	Common
SA	Blue	SA	Signal A
SB	Yellow	SB	Signal B

## WIRING DIAGRAM

Wiring Hub Model WH11 or WH32

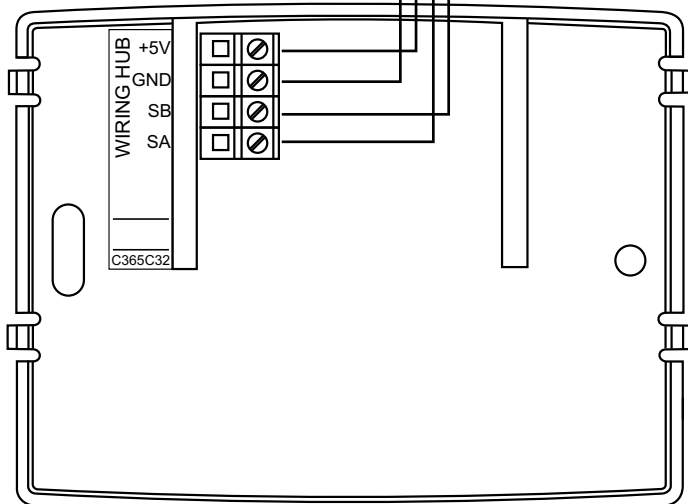
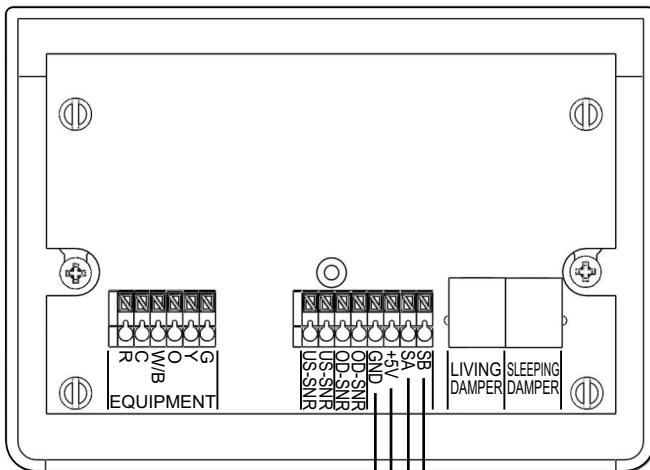

Thermostat Model C365C32 or C365C32WF

### Check for the following error messages:

#### Error Message No Communication

When the thermostat powers up, it will display the nC message indicating it has not established communication with the Wiring Hub. After about 10 seconds the thermostat will establish communication with the Wiring Hub and the nC message disappears.

The nC message will appear anytime communication with the Wiring Hub is lost or never established. Check the wiring between the thermostat and Wiring Hub and that the wires are secured in the correct terminals on the thermostat and Wiring Hub.

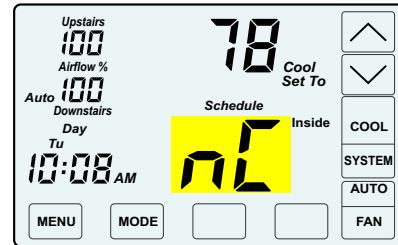

#### Error Message No Sensor

The thermostat displays the nS message indicating it has not detected an upstairs temperature sensor. Check the wiring between the sensor and Wiring Hub and that the wires are secured in the correct terminals on the Sensor and Wiring Hub. If a wireless temperature sensor is used, be sure the batteries are installed and the wireless sensor is set to the correct number.

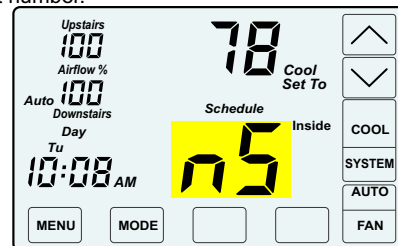

When an nS error is detected, the thermostat fully opens the Upstairs and Downstairs dampers and turns airflow control off as long as the nS error persists. It still maintains control of heating and cooling calls.

#### Error Message Wireless Sensor Lost

The thermostat displays the Err 01 or Err 02 message indicating it has lost communication with an upstairs, wireless temperature sensor. Check the batteries in the sensor and be sure they are set to the correct sensor#. If the error message persists, turn the power off to the Wiring Hub. When power is restored, the Wiring Hub automatically detects which sensors are being used and clears the error messages.

When an Err 01 error is detected, the thermostat alternately displays

Err  
01

When an Err 02 error is detected, the thermostat alternately displays

Err  
02

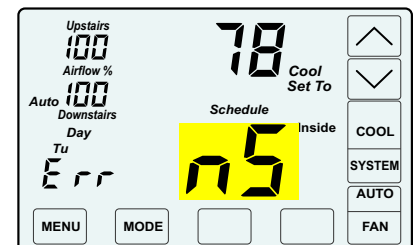

## Error Message No Power

nP is displayed when there is no power to the system. If the message is displayed when the system is powered, check the wiring from the thermostat to Wiring Hub and the Wiring Hub to the system for errors.

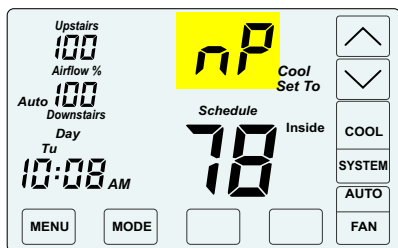

Press the touchscreen with your fingertip only, using a firm touch. Do not use a sharp object such as a pen or pencil.

## INSTALLER OPTIONS

Option	Description	Display	Range	Default
01	Equipment Type		GE or HP	GE
02	Heat Pump Type <i>(Only displayed if HP selected)</i>	HPt	Co or dF	Co
03	Outdoor Temperature Fossil fuel (OBP)	O8P	35 to 55F	40F
04	Compressor Stages	CPr	0 or 1 (GE), 0 to 2 (HP)	1 (GE), 2 (HP)
05	Heating Stages	HtG	0, 1 or 2	1
06	Fan Operation. <i>(Only displayed if GE selected)</i>	FAn	GA(Up) or EL(Down)	GA
07	Compressor Minimum Off Time (minutes).	COt	0 to 9	2
08	Gas Minimum Off Time (minutes).	HOt	0 to 9	0
09	Minimum Run Time (minutes).	r n t	0 to 9	1
10	On-Off Temperature Differential	O O <sup>o</sup>	0, 1 or 2	1
	0 Cooling On 1° above setpoint, Off at setpoint. Heating On1° below setpoint, Off at setpoint.			
	1 Cooling On 1° above setpoint, Off .5° below setpoint. Heating On1° below setpoint, Off .5° above setpoint.			
	2 Cooling On 1° above setpoint, Off 1° below setpoint. Heating On1° below setpoint, Off 1° above setpoint.			
11	Smart Recovery.	S r	On(Up) or Off(Down)	Off
12	Vacant Heating Setpoint.	V A C + Heat	44 to 75	65
13	Vacant Cooling Setpoint.	V A C + Cool	74 to 95	80
14	Calibrate Downstairs Sensor	C A L	+/- 5	NA
15	Calibrate Upstairs Sensor.	C A L	+/- 5	NA
16	Airflow Update Time	A F t	1 to 20 minutes	2
17	Night Level LCD Backlight	BL + Night	On(Up) or Off(Down)	On
18	Airflow Control On or Off	AFC	On(Up) or Off(Down)	On
19	Up Stage Time	USt	0 to 30 minutes	5
20	Maximum Upstairs Airflow in Heating.	HAF+Heat	100 to 155%	150%
21	Maximum Upstairs Airflow in Cooling.	CAF+Cool	100 to 155%	140%
22	Maximum Downstairs Airflow in Heating.	HAF+Heat	100 to 155%	150%
23	Maximum Downstairs Airflow in Cooling.	CAF+Cool	100 to 145%	140%
24	Maximum Temperature Difference Between Upstairs and Downstairs.	diF	0 to 10	2
25	Home Number	Home	1 to 8	1
26	Thermostat Location	tLo	dS or uS	dS
27	Factory Restore	Fr	No(Next) or Yes(Enter) + UP	NA

## ACCESSING INSTALLER OPTIONS

To access the Installer Options, **TOUCH** and **HOLD** the hidden Enter key for 7 seconds until the first Option appears on the screen.

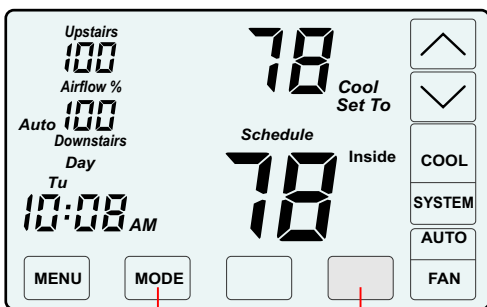

The hidden BACK key can be used to return to previous options.

**TOUCH** and **HOLD** this key for 7 seconds to access the Installer Options.

- ❗ **Press the touchscreen with your fingertip only, using a firm touch. Do not use a sharp object such as a pen or pencil.**
- ❗ **The NEXT key is used to display the next option.**
- ❗ **The ENTER key is used to save options and return to normal thermostat operation.**
- ❗ **The hidden BACK key is used to return to previous options and is located to the left of the NEXT key.**

### 01 Selecting the Equipment Type

Factory Default: GE. Range: GE or HP

This option is used to select gas/electric or heat pump equipment.

Touch the **UP/DOWN** keys to select gas/electric (GE) or heat pump (HP).

Touch **NEXT** or **ENTER**.

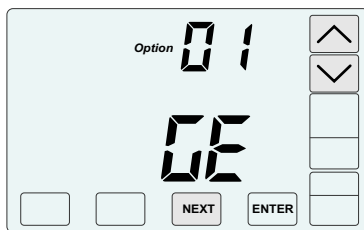

### 02 Heat Pump Type *(Only displayed if HP selected)*

Factory Default: Co. Range: Co or dF

This option is used to select a conventional HP(Co) with electric auxiliary heating or a dual fuel HP(dF) with fossil fuel auxiliary heating.

Touch the **UP/DOWN** keys to select Co for conventional HP or dF for dual fuel HP.

Touch **NEXT** or **ENTER**.

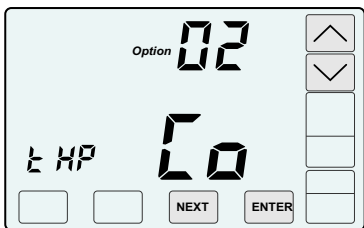

### 03 Dual fuel HP OBP *(Only displayed if HP selected)*

Factory Default: 40. Range: 35 to 55

This option is used to set the outdoor temperature at which the dual fuel heat pump switches to fossil fuel heating.

Touch the **UP/DOWN** keys to set the outdoor temperature limit.

Touch **NEXT** or **ENTER**.

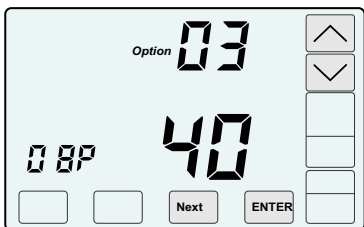

### 04 Setting the Compressor Stages

Factory Default: 1. Range: 0 or 1 for WH11 or 0 to 2 for WH32

This option is used to set the number of compressor stages.

Touch the **UP/DOWN** keys to set 0 or 1 stage.

Touch **NEXT** or **ENTER**.

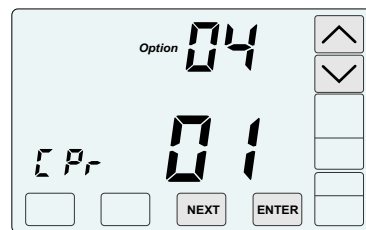

### 05 Setting the Heating Stages

Factory Default: 1 Stage. Range: 0 or 1 for WH11 or 0, 1 or 2 for WH32

This option is used to set the number of heating stages in a GE system or auxiliary heating stages in a HP.

Touch the **UP/DOWN** keys to set 0, 1 or 2 stages.

Touch **NEXT** or **ENTER**.

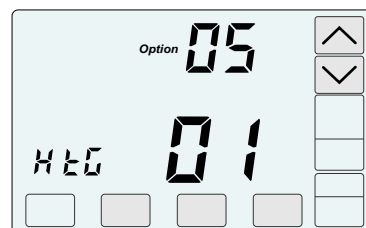

### 06 Setting the Fan Operation *(Only displayed if GE selected)*

Factory Default: Gas. Range: GA or EL

Touch the **UP** key to select "EL" for electric operation where the thermostat activates the indoor fan (G terminal) during heating calls or **DOWN** key to select GA for gas operation where the equipment plenum sensor activates the indoor fan in heating calls.

Touch **NEXT** or **ENTER**.

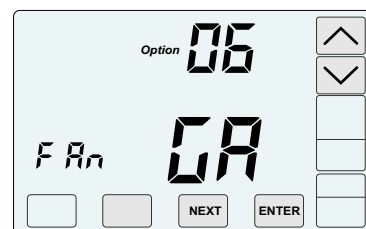

### 07 Compressor Minimum Off Time

Factory Default: 2 Minutes. Range: 0 to 9 Minutes

Touch the **UP/DOWN** keys to change the minimum off time (minutes) before restarting the compressor.

Touch **NEXT** or **ENTER**.

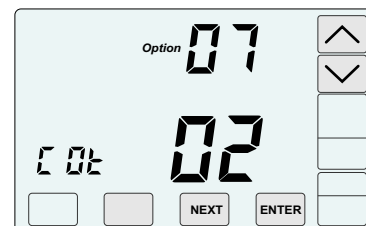

### 08 Heating Minimum Off Time

Factory Default: 0 Minutes. Range: 0 to 9 Minutes

Touch the **UP/DOWN** keys to change the minimum off time (minutes) before restarting a gas furnace or electric strip heater.

Touch **NEXT** or **ENTER**.

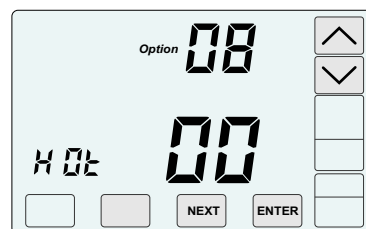

### 09 Minimum Run Time

Factory Default: 1 Minutes. Range: 0 to 9 Minutes

Touch the **UP/DOWN** keys to change the minimum run time (minutes) before turning a system off.

Touch **NEXT** or **ENTER**.

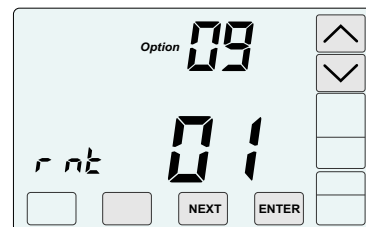

❗ The **NEXT** key is used to display the next option.

❗ The **ENTER** key is used to save options and return to normal thermostat operation.

❗ The hidden **BACK** key is used to return to previous options and is located to the left of the **NEXT** key.

## 10 Setting On-Off Temp Differential

Factory Default: #1. Range: 0, 1 or 2.

Touch the **UP/DOWN** keys to select 0, 1, 2.

Touch **NEXT** or **ENTER**.

Differential Mode0 0.5° On/Off Span.

Differential Mode1 1.0° On/Off Span.

Differential Mode2 1.5° On/Off Span.

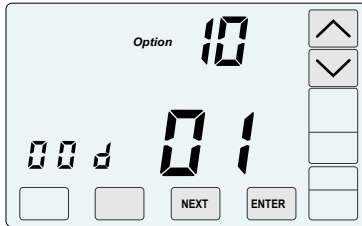

## 11 Smart Recovery

Factory Default: Off. Range: On or Off.

Smart recovery initiates a heating or cooling call so that the space is at temperature when the setback period ends.

Touch the **UP** key to select ON to turn on smart recovery or touch the **DOWN** key to select OF to turn smart recovery off.

Touch **NEXT** or **ENTER**.

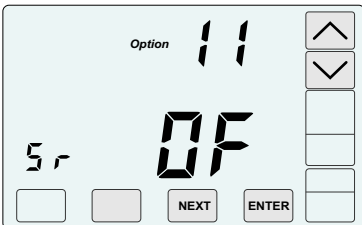

## 12 Vacant Heating Setpoint

Factory Default: 65°F. Range: 44°F to 75°F

Touch the **UP/DOWN** keys to select the heating temperature when the space is vacant.

Touch **NEXT** or **ENTER**.

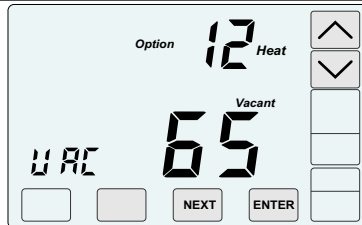

## 13 Vacant Cooling Setpoint

Factory Default: 80°F. Range: 74°F to 95°F

Touch the **UP/DOWN** keys to select the cooling temperature when the space is vacant.

Touch **NEXT** or **ENTER**.

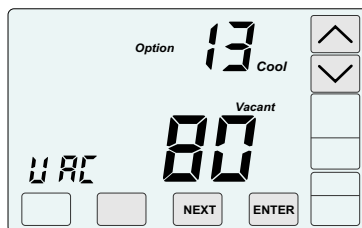

## 14 Calibrate Downstairs Temperature Sensor

Factory Default: None. Range - +/-5°

Touch the **UP/DOWN** keys to change the downstairs (Inside) temperature to the temperature that the user feels is correct.

Touch **NEXT** or **ENTER**.

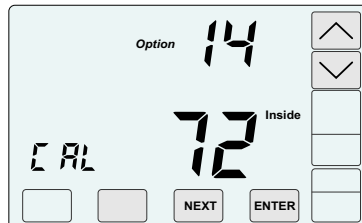

## 15 Calibrate Upstairs Temperature Sensor

Factory Default: None. Range - +/-5°

Touch the **UP/DOWN** keys to change the upstairs (Inside2) temperature to the temperature that the user feels is correct.

Touch **NEXT** or **ENTER**.

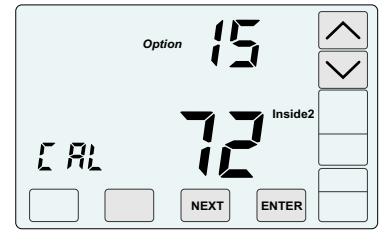

## 16 Airflow Update Time

Factory Default: 2 Minutes. Range: 1 to 20 Minutes.

This is the frequency, in minutes, that the damper position is updated.

Touch the **UP/DOWN** keys to set the time in minutes to update the upstairs and downstairs airflow.

Touch **NEXT** or **ENTER**.

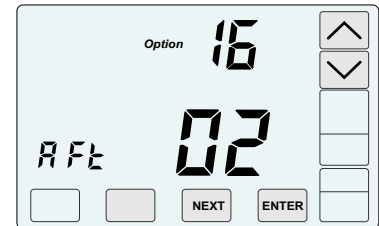

## 17 Night Level LCD Backlight

Factory Default: On. Range: On or Off.

The LCD has a low level backlight that can be used as a night light.

Touch the **UP** key to turn the low level backlight ON or touch the **DOWN** key to turn OFF.

Touch **NEXT** or **ENTER**.

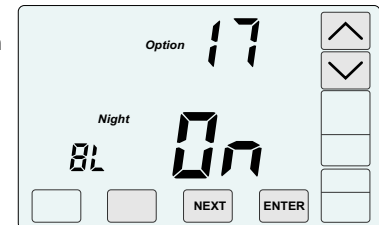

## 18 Airflow Control, On or Off

Factory Default: On. Range: On or Off.

This option turns the automatic airflow control on or off. If on, the thermostat will automatically adjust the airflow. If off, airflow is disabled.

Touch the **UP** key to select ON for airflow control or touch the **DOWN** key to select OFF to disable airflow control.

Touch **NEXT** or **ENTER**.

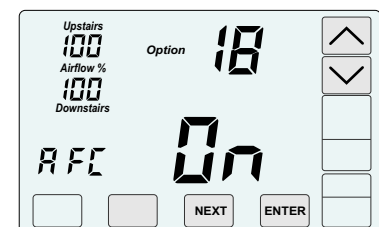

## 19 Upstaging Time

Factory Default: 5 minutes. Range: 0 to 30 minutes

Touch the **UP/DOWN** keys to set the time at which second stage heating or cooling is activated.

Touch **NEXT** or **ENTER**.

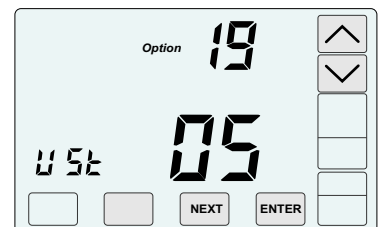

For options 20 - 23, use the installer test on pages 7-8 to determine the maximum allowable airflow.

### 20 Maximum Upstairs Airflow in Heating

Factory Default: 150%. Range: 100% to 155%.

Touch the **UP/DOWN** keys to select the maximum allowable upstairs airflow in heating.

Touch **NEXT** or **ENTER**.

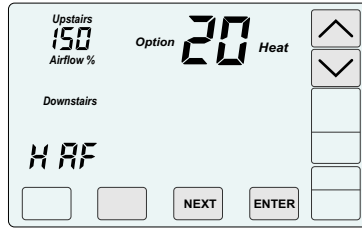

### 21 Maximum Upstairs Airflow in Cooling

Factory Default: 140%. Range: 100% to 155%.

Touch the **UP/DOWN** keys to select the maximum allowable upstairs airflow in cooling.

Touch **NEXT** or **ENTER**.

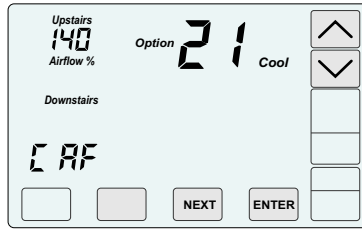

### 22 Maximum Downstairs Airflow in Heating

Factory Default: 150%. Range: 100% to 155%.

Touch the **UP/DOWN** keys to select the maximum allowable downstairs airflow in heating.

Touch **NEXT** or **ENTER**.

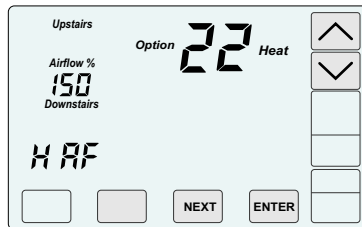

### 23 Maximum Downstairs Airflow in Cooling

Factory Default: 140%. Range: 100% to 145%.

Touch the **UP/DOWN** keys to select the maximum allowable downstairs airflow in cooling.

Touch **NEXT** or **ENTER**.

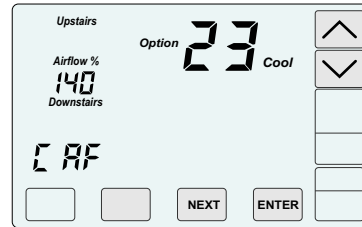

### 24 Maximum Temperature Differential

Factory Default: 2°F. Range: 0° to 10° F

Maximum allowable temperature difference between the upstairs and downstairs temperatures. When the temperature difference is equal to or greater than the allowed differential, the airflow is adjusted.

Touch the **UP/DOWN** keys to select the maximum allowable temperature difference between the upstairs and downstairs.

Touch **NEXT** or **ENTER**.

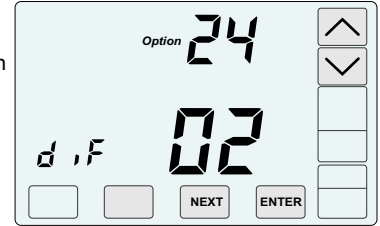

### 25 Wireless Home Number

Factory Default: 1. Range: 1 to 8

When 2 or more Comfort365 systems with wireless sensors are installed within 300 feet of one another, the installations have to be set to different Home Numbers used in wireless communication

Touch the **UP/DOWN** keys to select a new Home Number for one of the installations.

Touch **NEXT** or **ENTER**.

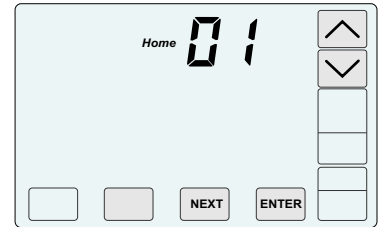

### 26 Thermostat Location

Factory Default: dS. Range: dS or uS

In most homes the thermostat is located downstairs. If the thermostat is located Upstairs this option can be used to instruct the thermostat to where it is installed.

Touch the **UP** key to select the thermostat located Upstairs (uS) or press the Down key to select Downstairs (dS).

Touch **NEXT** or **ENTER**.

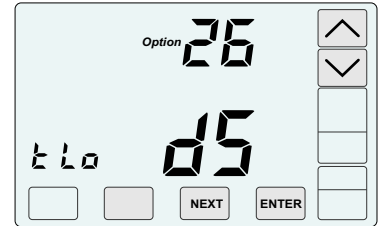

### 27 Factory Restore

**WARNING! Factory Restore resets ALL settings.**

Touch **NEXT** or **ENTER** to return to normal thermostat operation. Touch the hidden **BACK** key to return to previous option.

To restore factory settings, touch **ENTER**, then touch the **UP** key.

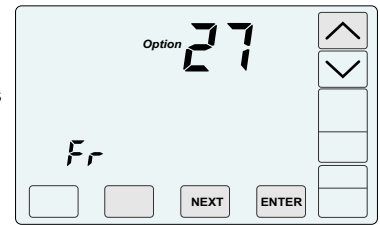

## ACCESSING THE TEST MENU

The Test Menu is used to test the Indoor Fan Operation, Allowable Heating Airflow Limits and Allowable Cooling Airflow Limits.

The Test Menu can also be used to perform the HERS Total Airflow test. Option 05-06 activates a cooling call and opens both dampers to 100% enabling the installer to perform the test.

To access the Test Menu, **TOUCH** and **HOLD** the hidden Next key for 7 seconds until the fan test screen (Option 01) appears.

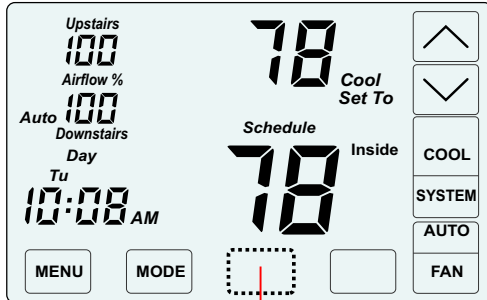

**TOUCH** and **HOLD** this key for 7 seconds to access the Installer Options.

## 01-02 Testing Indoor Fan Operation

This test is used to verify that the indoor fan is operating correctly.

In Option 1, the Fan is Off.

Touch **NEXT** to go to Option 2 to turn on the indoor fan. Verify the fan is operating and delivering airflow to the upstairs and downstairs..

Touch **NEXT** to go Testing Heating Airflow Limits.

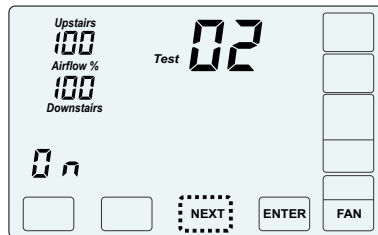
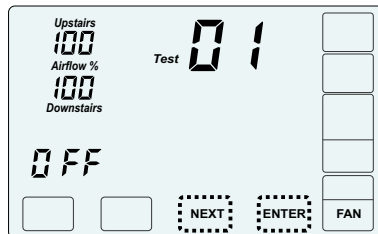

## 03-04 Testing Heating Airflow Limits

This test is used to determine the maximum allowable upstairs airflow and the maximum allowable downstairs airflow in HEATING.

In Option 3, the system is Off.

Touch **NEXT** to go to Option 4 to activate heating. Verify the equipment is operating.

To determine the maximum allowable upstairs airflow, touch the **UP** key until the airflow is too great and causes noise or annoyance. Lower the airflow using the **DOWN** key until it is acceptable. This is the maximum allowable upstairs airflow in heating. Record the airflow value.

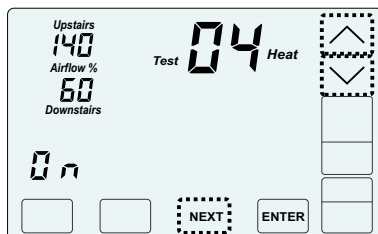
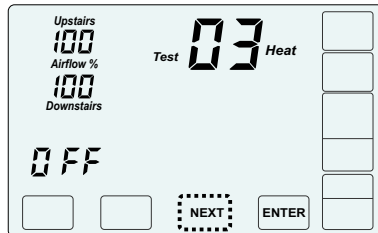

Maximum Allowable Upstairs Airflow in Heating

## 03-04 Testing Heating Airflow Limits (cont.)

To determine the maximum allowable downstairs airflow, touch the **DOWN** key until the airflow is too great and causes noise or annoyance. Increase the airflow using the **UP** key until it is acceptable. This is the maximum allowable downstairs airflow in heating. Record the airflow value.

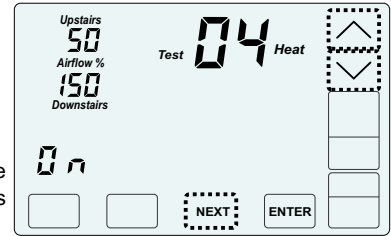

Maximum Allowable Downstairs Airflow in Heating

Touch **NEXT** to go to Testing Cooling Airflow Limits.

## 05-06 Testing Cooling Airflow Limits

This test is used to determine the maximum allowable upstairs airflow and maximum allowable downstairs airflow in COOLING.

The test can also be used to perform the HERS Total Airflow test. The test activates a cooling call and opens both dampers to 100%.

In Option 5, the system is Off.

Touch **NEXT** to go to Option 6 to activate cooling. Verify the equipment is operating.

To determine the maximum allowable upstairs airflow, touch the **UP** key until the airflow is too great and causes noise or annoyance. Lower the airflow using the **DOWN** key until it is acceptable. This is the maximum allowable upstairs airflow in cooling. Record the airflow value.

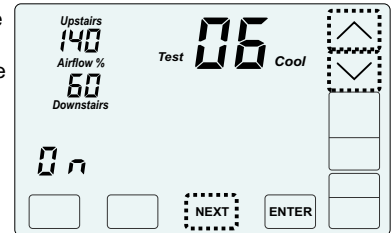
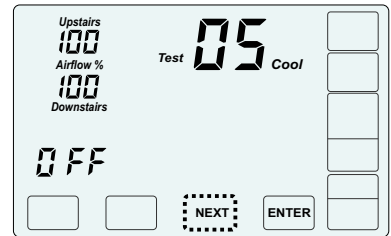

Maximum Allowable Upstairs Airflow in Cooling

To determine the maximum allowable downstairs airflow, touch the **DOWN** key until the airflow is too great and causes noise or annoyance. Increase the airflow using the **UP** key until it is acceptable. This is the maximum allowable downstairs airflow in cooling. Record the airflow value.

Maximum Allowable Downstairs Airflow in cooling

Touch **ENTER** to end testing and return to normal thermostat operation.

Enter the maximum airflow limits using Options 20 through 23 of the installer menu.