

The Comfort365 is a touch screen programmable thermostat that controls heating, cooling and airflow. The thermostat monitors the upstairs temperature sensor and automatically adjusts the upstairs and downstairs airflow to provide uniform comfort.

The thermostat is WiFi enabled and allows you to operate your thermostat remotely using your smartphone, tablet, laptop or PC.

The energy saving nighttime option uses the upstairs temperature sensor to control heating and cooling calls and increases the upstairs airflow.

The user can manually adjust the airflow on occasions when more airflow is needed upstairs or downstairs.



## User Options and Settings

P.1 Quick Reference	P.5 Temperature Override	P. 6-7 User Options (cont.)
P.2-3 Setting Up WiFi Access	P.5 Displaying Upstairs Temperature	Turning Nighttime Airflow On or Off
P.4 Remote Thermostat Access	P.6 Overriding Automatic Airflow Option	Setting Nighttime Airflow in Heating
P.4 Error Messages	P.6 Terminating Automatic Airflow	Setting Nighttime Airflow in Cooling
P.4 Set Time of Day	P.6-7 User Options	Cleaning the Touchscreen
P.4-5 Set System, Fan and Thermostat Mode	Set Schedule	Turning WiFi On or Off
P.5 Changing Setpoint Temperature	Selecting Manual or Auto Airflow	Start Linking WiFi Thermostat

## Quick Reference

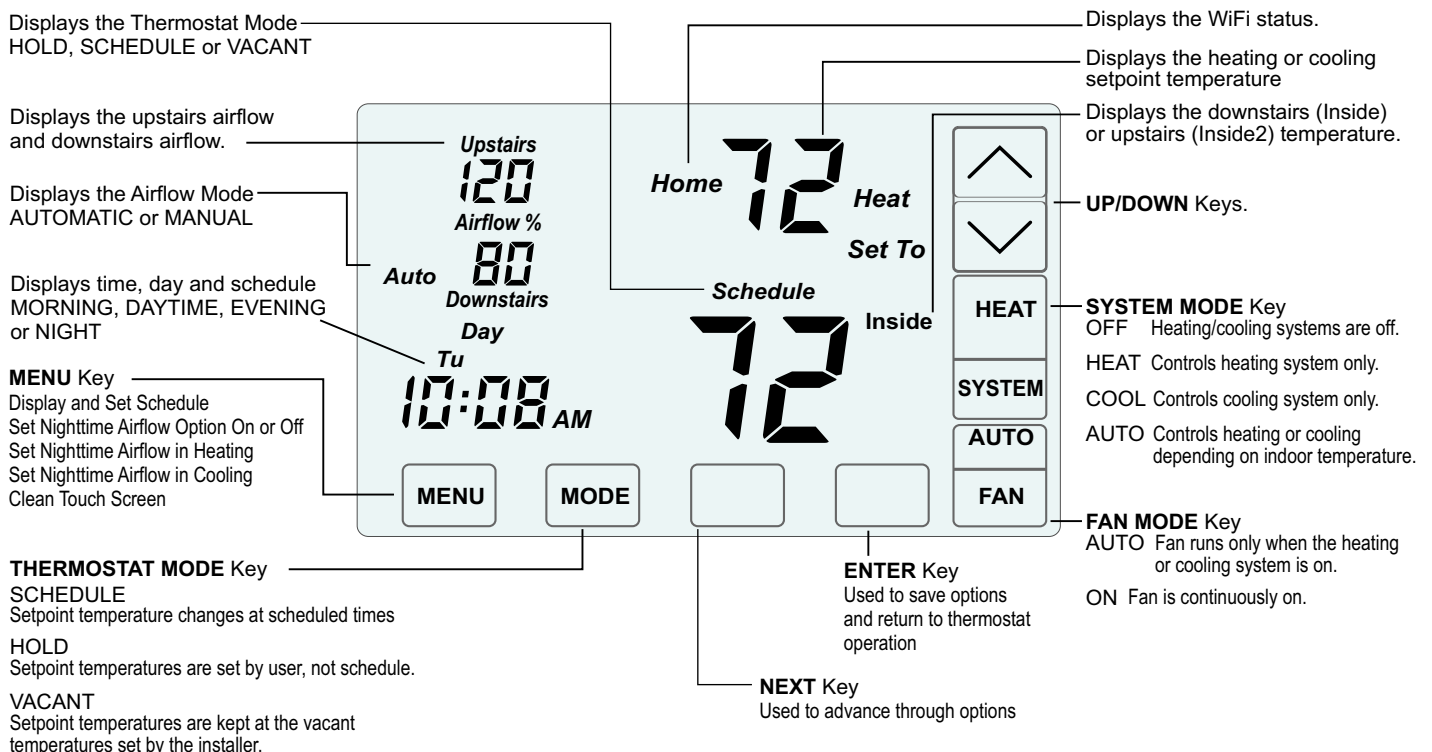

The following will guide you through setting up your Comfort365 remote access using your home network.

User options and settings accessed through the thermostat are outlined on pages 4-8.

 Google Chrome web browser works best for access.

## Setting Up Your WiFi Access

### 1 Set Up Comfort365 WiFi Account

1. **Open Google Chrome** on your smart phone or PC.

2. In the address bar, **type** the following:

**www.365-US.com**

 Apple product users may need to type the following:

**http://www.365-US.com**

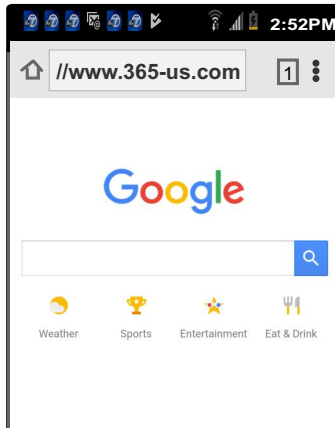

3. Touch **Register Here** to set up your account.

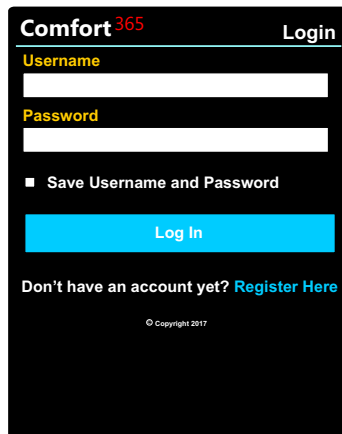

4. **Enter your Username.**

5. **Enter your Password.** Password is case sensitive.

6. **Reenter Password.**

**Do not** check the Save Username/password box.

Be sure to record the Username and Password in a safe place for future reference.

7. Touch **NEXT.**

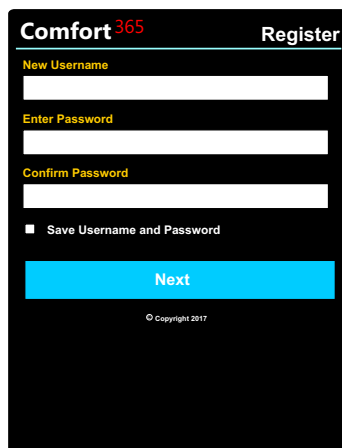

The Comfort365 Home page is displayed.

8. **Close the browser** window.

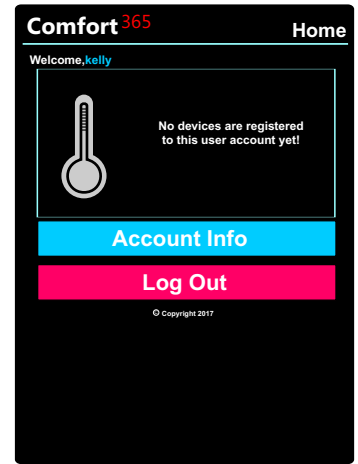

### 2 Turn Thermostat WiFi On

Turning the C365 WiFi on starts the linking of the C365 WiFi thermostat to the home's WiFi network using any smart device or PC.

1. Touch the **MENU** key to access User Options.

2. Continue to touch and release the **MENU** key until **nEt** is displayed.

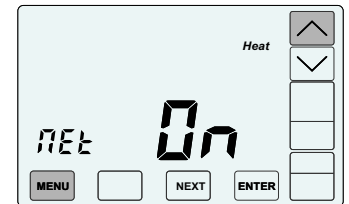

This option turns WiFi on or off.

3. Touch the **UP** key to select **On**, then touch **MENU**.

**Lnc** is displayed - Option for Linking WiFi Thermostat.

4. Touch the **UP** key to select **On**.

5. Touch the **ENTER** key to save.

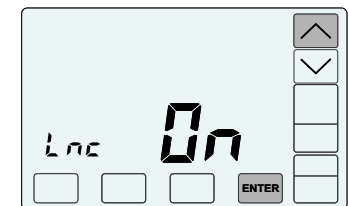

"Home" will blink, indicating the thermostat is ready to link with the home router.

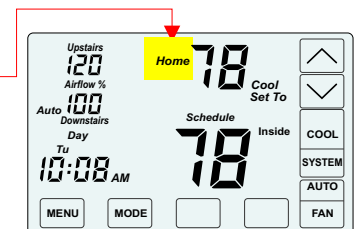

### 3 Setting Up WiFi Connection

1. Open your WiFi settings on your smart phone or PC to display the available networks.

2. Select the **C365 WiFi network**. The name will be something like:

**C365T21WF\_####**

where #### is a randomly assigned 4 digit number.

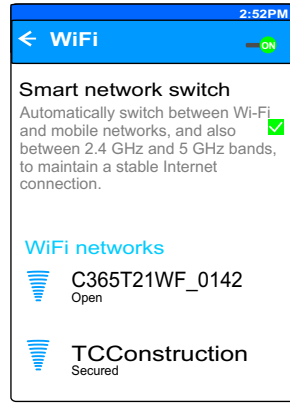

3. Select **CONNECT**.

You may receive the following message:

**"Internet May Not Be Available"**

Touch **OK**.

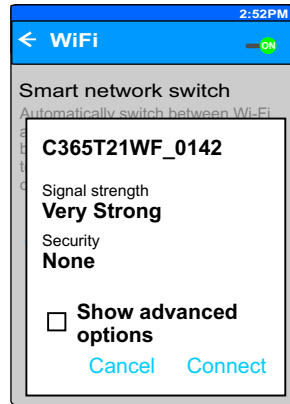

The Comfort365 WiFi thermostat WiFi network displays **CONNECTED**.

4. Close the WiFi Settings page.

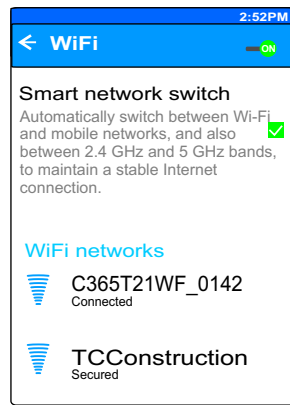

### 4 Connecting To Home Network

1. Open Google Chrome on your smart phone or PC.

2. In the address bar, type the following:

**192.168.8.2**

Apple product users may need to type in the following:

**http://192.168.8.2**

The WiFi Setup page will be displayed.

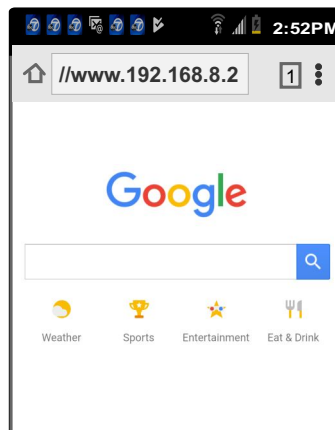

### 4 Connecting To Home Network (Continued)

3. Enter your **C365 Username** in the "Username box", if not already displayed.

4. Select your **WiFi network** from the pull down menu, if not already displayed.

5. Enter your **WiFi password**, if not displayed.

6. Touch **SAVE**.

Use Advanced Options only if your network requires advanced settings

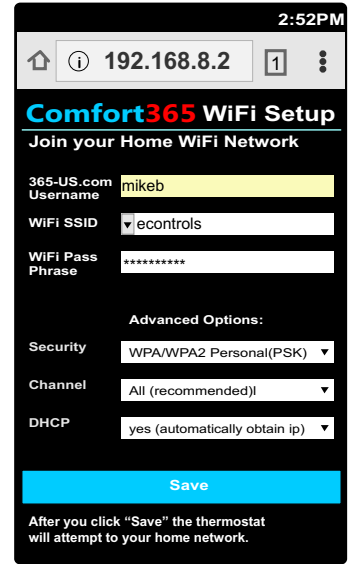

7. Touch **OK**.

8. Close the browser window.

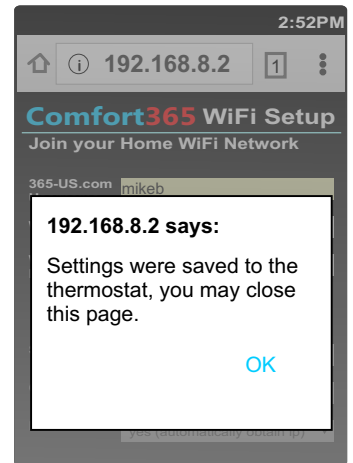

Once connected, Home will display continuously.

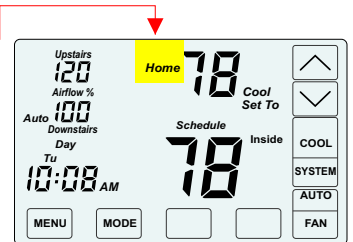

If you are having trouble connecting, close the browser window. Repeat Steps 2, 3 and 4 and then try connecting again.

9. Check to make sure your WiFi has reconnected to your network.

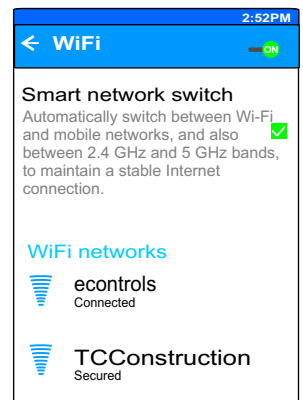

## Remote Thermostat Access

1. Open **Google Chrome** on your smart phone or PC.

2. In the address bar, **type** the following:  
**www.365-US.com**

1. Enter your **Username**.
2. Enter your **Password** (username and password are case sensitive).

Select **Save Username and Password** for easy log in next time.

Touch **Log In** to access your thermostat.

## Accessing Thermostat

The Home page allows you to view and change settings for your thermostat remotely

Touch the icon  to view or change thermostat settings.

Or, touch **Account Info** to edit your account information.

Touch **Log Out** to return to the Log In page.

## View / Change Thermostat Settings

This page allows you to view and, set a number of options including:

Edit Nickname

View Living (Downstairs) Temperature

View Bedrooms (Upstairs) Temperature

View Equipment Status

Select System Mode

- Off
- Auto
- Heating
- Cooling

Select Thermostat Mode

- Schedule
- Hold/Manual
- Vacant

Select Fan Mode

- Auto (most commonly used)
- Continuous (On)

Adjust the Cooling Setpoint

Adjust the Heating Setpoint

Set the Sort Priority (if you have more than one Comfort365 thermostat)

Touch **Back** to save settings and return to Home page.

## Error Messages

### No Power Message

**nP** is displayed when there is no power to the system. If the message is displayed when there is no interruption in power to the home, contact your HVAC contractor/builder. Wiring from the thermostat to the system needs to be checked for errors.

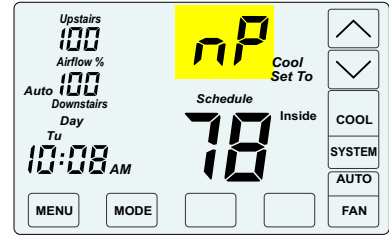

### Sensor Error Message

**nS** is displayed when there is an error with the upstairs sensor(s). If the message is displayed, contact your HVAC contractor/builder. The sensor wiring needs to be checked for errors.

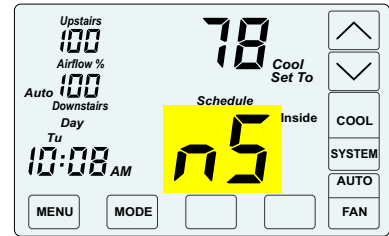

When the **nS** message is displayed, the thermostat will continue to control the system but the airflow control will be disabled until the sensor error is corrected.

Press the touchscreen with your fingertip only, using a firm touch. Do not use a sharp object such as a pen or pencil. Note: The thermostat touchscreen uses a different "touch" technology than touch phones and therefore reacts to your touch differently.

## Set Time and Day

Touch here to change the time and day of the week.

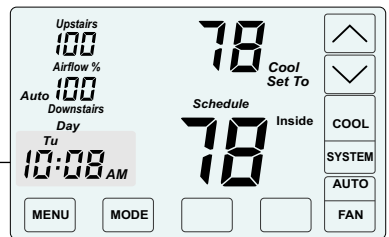

### CHANGE THE HOUR

Touch the **UP/DOWN** keys to change the HOUR. Touch **NEXT** to save the hour and go to change the minute.

### CHANGE THE MINUTE

Touch the **UP/DOWN** keys to change the MINUTE. Touch **NEXT** to save the minute and go to change the day of the week.

### CHANGE THE DAY OF THE WEEK

Touch the **UP/DOWN** keys to change the DAY OF THE WEEK.

Touch **ENTER** to save the day of the week and return to thermostat operation.

## Set System Mode

Touch the **SYSTEM** key to display the SYSTEM MODES - OFF, HEAT, COOL, or AUTO. When HEAT is selected, the heating setpoint is displayed. When COOL is selected, the cooling setpoint is displayed. In AUTO or OFF, the setpoint for the last system call is displayed.

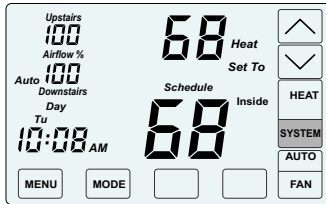

Touch and hold the **SYSTEM** key to select:

- OFF** Heating and cooling systems are off.
- HEAT** Only heating calls are enabled.
- COOL** Only cooling calls are enabled.
- AUTO** Heating or Cooling calls are enabled.

## Set Fan Mode

Touch the **FAN** key to display the FAN MODES - AUTO or ON. AUTO is the most commonly used setting.

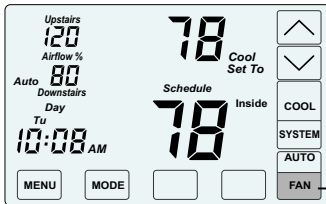

Touch **FAN** key to select:

- AUTO** Fan is activated only during heating or cooling calls.
- ON** Fan is continuously on.

## Set Thermostat Mode

Touch the **MODE** key to display the THERMOSTAT MODES - SCHEDULE, HOLD and VACANT.

In SCHEDULE MODE, the setpoint temperature is automatically changed at the scheduled times as long as the SYSTEM MODE is in AUTO. In HOLD MODE, the thermostat uses the temperatures set by the user, ignoring the schedule. In VACANT MODE, the thermostat uses the energy saving Vacant heating and cooling setpoints set by the installer until the mode is changed.

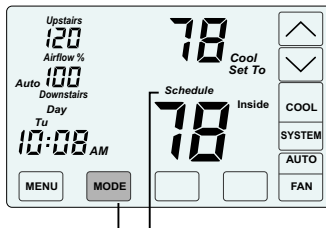

Touch and hold the **MODE** key to select:

- SCHEDULE** Setpoint temperatures are changed at scheduled times defined by the user.
- HOLD** Setpoint temperatures are set by the user. No schedule is used.
- VACANT** Setpoint temperatures are kept at the vacant temperatures set by the installer.

Displays the Mode.

## Changing the Setpoint Temperature

The UP/DOWN keys are used to change the setpoint temperature.

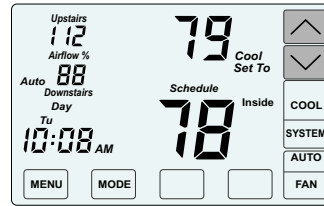

Touch the **UP** key to raise setpoint temperature.

Touch the **DOWN** key to lower setpoint temperature.

An active heating call is indicated by HEAT blinking. An active cooling call is indicated by COOL blinking.

To display the opposing system setpoint, touch the area shown below.

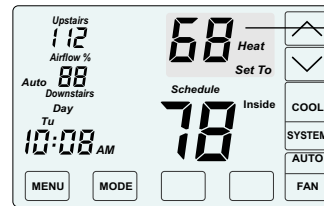

Touch here to display and change the opposing setpoint temperature.

Touch the **UP/DOWN** keys to change the setpoint temperature for the opposing system. The thermostat will return to displaying the active setpoint after about 30 seconds.

## Temperature Override

If the thermostat is in SCHEDULE MODE, the setpoint temperature can be overridden using the UP/DOWN keys. The setpoint temperature will be held for 3 hours. After 3 hours the thermostat returns to normal operation.

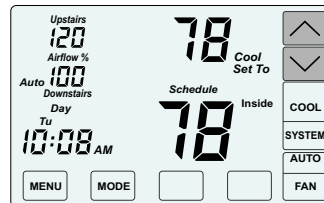

Touch the **UP/DOWN** keys to adjust the setpoint temperature.

After 3 hours, the thermostat returns to normal thermostat operation.

## Displaying the Upstairs Temperature

The thermostat displays the downstairs temperature and is indicated by INSIDE. The upstairs temperature will be indicated by INSIDE2. In Night Mode, the thermostat displays the upstairs temperature, indicated by INSIDE2.

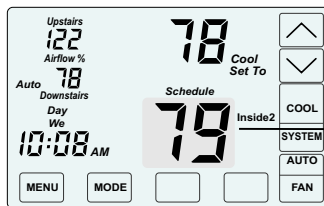

To display the upstairs temperature, touch the **INSIDE** temperature as indicated. The thermostat will now display the upstairs temperature, indicated by **INSIDE2**.

After about 30 seconds, the thermostat will return to displaying the downstairs temperature.

## Overriding Automatic Airflow

In AUTOMATIC AIRFLOW MODE, the user can override the airflow to the upstairs and downstairs by pressing **AIRFLOW %** in the area shown and then use the **UP/DOWN** keys to adjust the airflow. After 3 hours, the thermostat returns to automatic operation. UPSTAIRS, AIRFLOW% and DOWNSTAIRS blink when in airflow override.

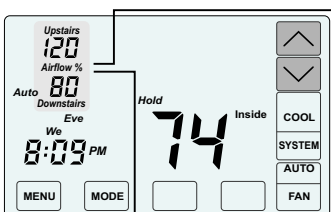

Touch **AIRFLOW%** as shown.

Touch the **UP** key to increase the upstairs airflow (the downstairs airflow will automatically decrease). Touch the **DOWN** key to increase downstairs airflow (the upstairs airflow will automatically decrease).

This area will blink when in airflow override.

The override range is defined by the installer during set up.

## Terminating Airflow Override

AIRFLOW OVERRIDE can be terminated by pressing **AIRFLOW %** in the area shown and then pressing the **Mode** key. The thermostat returns to automatic airflow control. The AIRFLOW % returns to the airflow prior to the override.

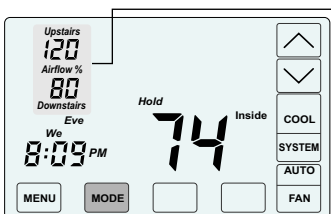

Touch **AIRFLOW%** as shown.

Touch the **MODE** key to terminate airflow override.

The thermostat returns to automatic airflow control. The AIRFLOW % returns to the airflow prior to the override.

## User Options

- Set Schedule
- Selecting Manual or Auto Airflow
- Turning Nighttime Airflow Option On or Off
- Setting Nighttime Airflow in Heating
- Setting Nighttime Airflow in Cooling
- Cleaning the Touchscreen
- Turning WiFi On or Off
- Linking WiFi Thermostat

## Factory Set Schedule

The thermostat comes pre-set with the following energy-saving schedule for weekdays (Monday-Friday) and weekends (Saturday-Sunday). Using these settings can reduce your heating/cooling expenses.

Monday through Friday	Time	Heat	Cool
Morn	6:00 AM	70	75
Day	8:00 AM	62	83
Even	6:00 PM	70	75
Nite	10:00 PM	62	78
Saturday and Sunday	Time	Heat	Cool
Morn	6:00 AM	70	75
Day	8:00 AM	62	83
Even	6:00 PM	70	75
Nite	10:00 PM	62	78

## Change Factory Set Schedule

Touch the **MENU** key to display SCHEDULE. Here you will select either the weekday or weekend schedule to display or change.

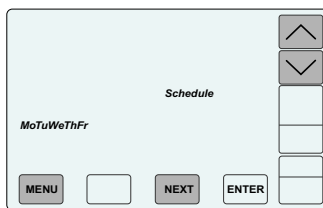

### SELECTING THE WEEKDAY OR WEEKEND SCHEDULE

Touch the **UP** key to select the weekday schedule (MoTuWeThFr) or touch the **DOWN** key to select the weekend schedule (SaSu) and then touch **NEXT**.

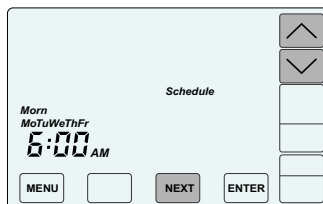

### SETTING THE MORNING SCHEDULE START TIME.

Touch the **UP/DOWN** keys to change the Morning Schedule Start Time and then touch **NEXT**.

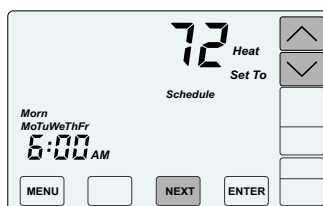

### SETTING THE MORNING SCHEDULE HEATING TEMPERATURE.

Touch the **UP/DOWN** keys to change the Morning Schedule Heating Setpoint and then touch **NEXT**.

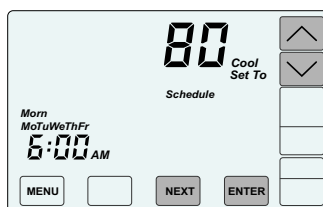

### SETTING THE MORNING SCHEDULE COOLING TEMPERATURE.

Touch the **UP/DOWN** keys to change Morning Schedule Cooling Setpoint and then touch **NEXT**.

Continue setting the start times, heating setpoints, cooling setpoints for the Day, Evening and Night schedules.

Touch **ENTER** to save the schedules to the weekdays or the weekend.

## Selecting Manual or Auto Airflow

This option is only displayed if your installer enabled Manual Airflow Control during installation. AUTOMATIC AIRFLOW is the default. In AUTOMATIC AIRFLOW CONTROL, the airflow is adjusted by the thermostat. In MANUAL AIRFLOW CONTROL, the user must adjust the airflow. The airflow range is defined by the installer during set up.

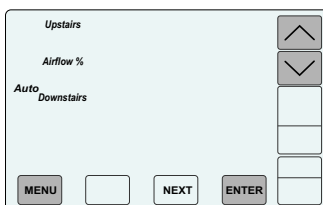

Touch the **MENU** key until the following thermostat screen is displayed.

Touch the **UP** key to select AUTO. Touch the **DOWN** key to select MANUAL.

Touch the **MENU** key to save and go to next option or touch the **ENTER** key to save the options.

## Turning Nighttime Airflow Option On or Off

When bedrooms are located upstairs, the NIGHTTIME AIRFLOW option can be used to save energy. The thermostat uses the upstairs temperature sensor for controlling heating and cooling calls, as if the thermostat has been moved upstairs. The airflow downstairs is reduced and the upstairs airflow is increased.

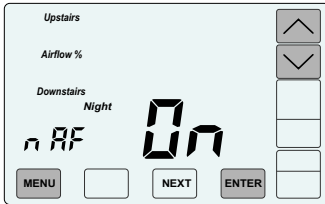

Touch the **MENU** key to display NIGHTTIME AIRFLOW option indicated by nAF On or Off.

Touch the **UP** key to turn the option ON. Touch the **DOWN** key to turn the option OFF.

Touch the **MENU** key to save and go to next option or touch the **ENTER** key to save the options.

## Setting the Nighttime Airflow in Heating

This option enables the user to set the maximum allowable upstairs airflow in heating DURING NIGHTTIME OPERATION, not to exceed the installer set maximum allowable upstairs airflow in heating.

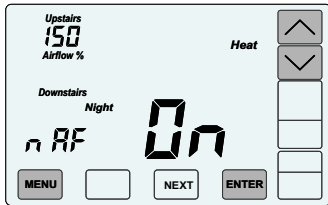

Touch the **MENU** key to display NIGHTTIME, UPSTAIRS AIRFLOW IN HEATING indicated by nAF Heat.

Touch the **UP/DOWN** keys to adjust the airflow.

Touch the **MENU** key to save and go to next option or touch the **ENTER** key to save the options.

## Setting the Nighttime Airflow in Cooling

This option enables the user to set the maximum allowable upstairs airflow in cooling DURING NIGHTTIME OPERATION, not to exceed the installer set maximum allowable upstairs airflow in cooling.

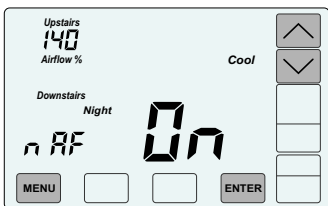

Touch the **MENU** key to display NIGHTTIME, UPSTAIRS AIRFLOW IN COOLING indicated by nAF Cool.

Touch the **UP/DOWN** keys to adjust the airflow.

Touch the **MENU** key to save and go to next option or touch the **ENTER** key to save the options.

## Cleaning the Touch Screen

This option disables the touch screen for 30 seconds to enable the user to clean the touch screen by wiping down with a soft, damp cloth.

The CLEAN DISPLAY option indicated by CL. The timer will count down and return to normal thermostat operation after 30 seconds. The remaining time is displayed on the screen.

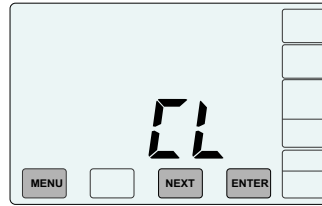

Touch the **MENU** key to display CLEAN DISPLAY option indicated by CL.

Press **ENTER** to start the 30 second count down. The touch screen is disabled during this time.

Or, press **NEXT** to return to normal thermostat operation

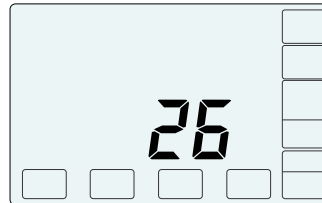

## Turning WiFi On/Off

This option enables the user to turn WiFi access on or off at anytime.

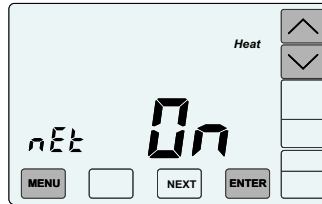

Touch the **UP/DOWN** keys to turn the WiFi on or off.

Touch the **MENU** key to go to next option or touch the **ENTER** key to save the options and return to normal thermostat operation.

## Start Linking the WiFi Thermostat

This option enables the linking of the C365T21WF to the home's WiFi network using any smart device and should only be changed during the WiFi setup.

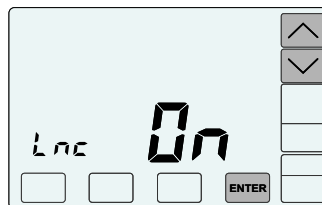

Touch the **UP/DOWN** keys to select On to start the linking sequence.

Touch the **ENTER** key to save the options and return to initiate the linking sequence.

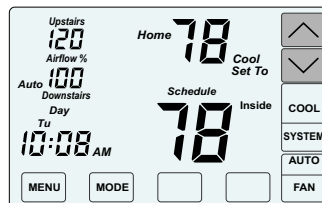

During the linking sequence "Home" will blink to indicate the thermostat is trying to link with the home router. Once the thermostat has linked with the home router and the cloud "Home" will be on continuously.

## Install Two AA Batteries

The batteries power the clock when 24VAC power is lost. Slide the battery cover downward and install the two AA batteries as shown.

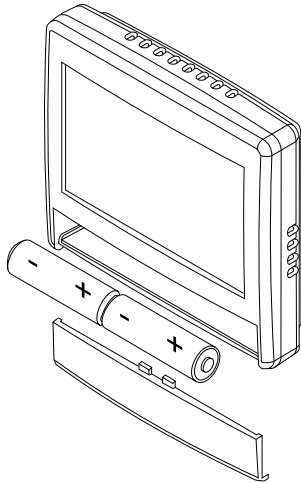

## Lost WiFi User Name and Password

If the user name and/or password have been forgotten or misplaced, the Comfort365 can be reconnected to the home network using a new user name and password.

Follow all the instructions starting with Setting Up Your WiFi Access, using a new user name and password.

## Demand Side Management

When participating in Demand Side Management with the utility company, the thermostat will display UC (Utility Control) when the utility company has limited the cooling setpoint setting in the thermostat.

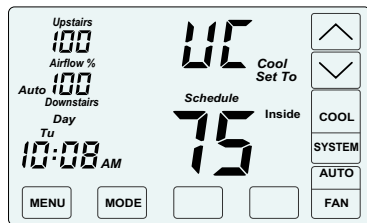

Homeowner resources are available online at [www.Comfort365USA.com](http://www.Comfort365USA.com), including a consumer video describing the features and outlining the operation of the Comfort365.

## Warranty

This thermostat is warranted to be free of defects due to workmanship or materials under normal use and service for a period of 5 years from date of installation and not longer than 6 years from manufacturing date code.

# eControls

eControls, 26072 Merit Circle #110, / Laguna Hills, CA 92653  
949-916-0945 [www.eControlsUSA.com](http://www.eControlsUSA.com)