

Direct Damper Control

User and Installer Manual Model WRCD and R80DWL

Rev Mar 2017

The Wireless Remote Control, WRCD, controls airflow into a space wirelessly using a wirelessly controlled, modulating damper installed in the duct supplying airflow to the space.

- Controls the airflow to up to 8 zones with each zone having one or multiple wireless dampers.
- Wireless range is 125' in a home or building.
- Airflow can be set from 0 to 100% in 5% increments.
- A home Address can be used when two or more installations are within 300' of one another.
- Dampers are powered by 24VAC transformer. 40VA transformer can power 10 dampers.
- Control airflow to home offices, garages, multi-media rooms or unused bedrooms.
- Control airflow to conference rooms, spare offices or any space that is not used continuously.
- Adjust airflow to spaces and eliminate overheating and overcooling and provide improved comfort.



Model WRCD
Wireless Remote Control



Model R80DWLXX
Wireless Control Damper

Caution! Direct Damper Controls are not an alternative to zoning. Installing too many controls on a single HVAC system could cause airflow and pressure problems.

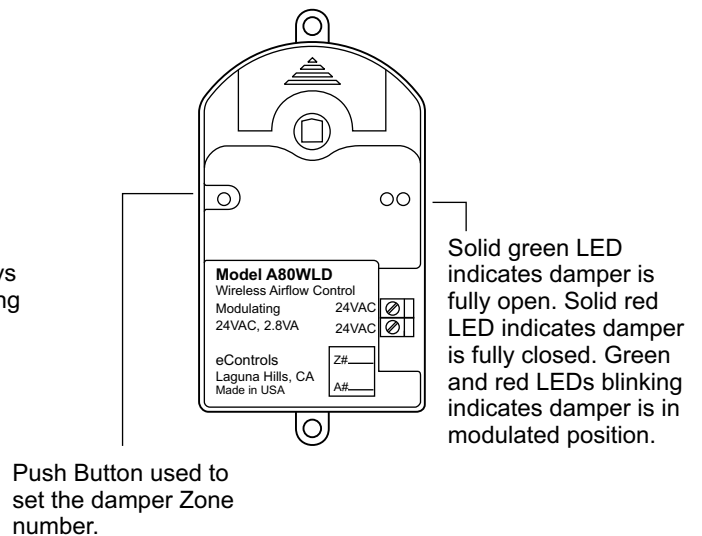
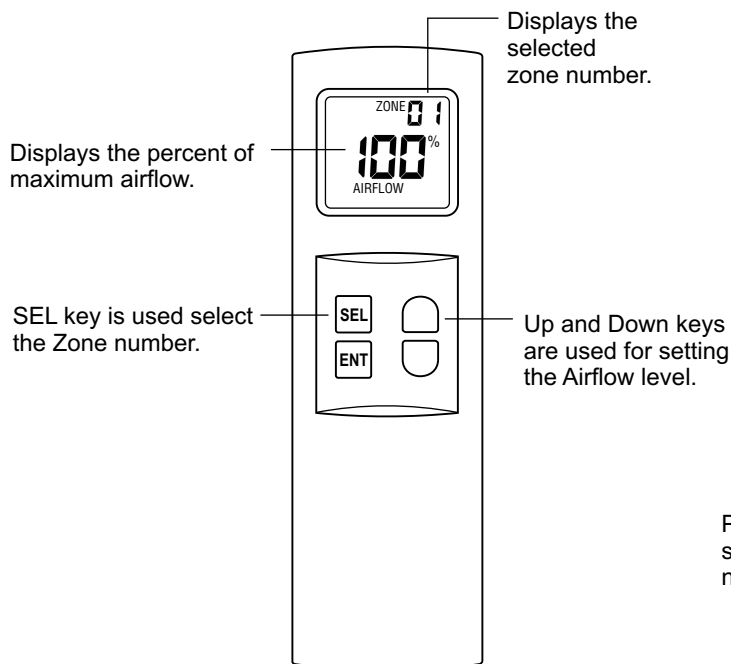

USER

Adjusting Airflow

Most installations are used to control airflow to a single space or zone with one or multiple dampers and only the **Up** and **Down** keys are required to control airflow.

1. Press the **UP** or **DOWN** keys to set the airflow. The **ENT** key can be pressed after the airflow is set or the Remote Control will automatically send the new airflow setting to the wireless dampers in a few seconds.

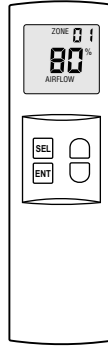

Changing the Zone Number

For installations controlling airflow to 2 or more spaces or zones, the Zone number must be selected before changing the airflow.

1. Press the **SEL** key. Zone number will be displayed.
2. Press the **UP** or **DOWN** keys to change the Zone number.
3. Press **ENT** key to display airflow for the the Zone number selected.



Changing the Home Address

When two or more installations are within 300' of one another, the second, third, etc., Remote Control and their wireless dampers must be set to a different home address.

1. Press and hold the **ENT** key. The LCD display will be blank. While holding the **ENT** key, press the **SEL** key to display the Address.
2. Press the **UP** or **DOWN** keys to change the Address number.
3. Press **ENT** key to display the Zone1 airflow for the Address number selected.

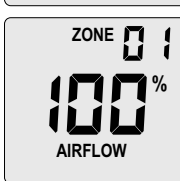

Low Battery Warning

When batteries are low, the display will show "Lob" and the batteries should be changed. Lithium AAA batteries can be used for longer life.

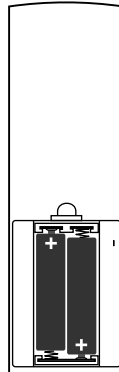
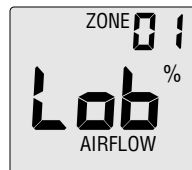

Remove battery cover and install two AAA batteries as shown.

INSTALLER

⚠ CAUTIONS

- Read and follow all instructions carefully.
- Read entire manual before installing products.
- Follow all local electrical codes during installation. All wiring must conform to local and national electrical codes.
- Use cautions when mounting components to surfaces that may have concealed wiring beneath the surface.

⚠ Ensure that the installation process does not alter the damper in a way that will cause interference to the blade moving freely.

Caution! Direct Damper Controls are not an alternative to zoning. Installing too many controls on a single HVAC system could cause airflow and pressure problems.

1) Damper Installation

The damper or dampers controlling airflow to the space should be installed in the supply duct providing airflow to the space. In commercial installations the damper can be installed into the supply diffuser.

The dampers should be mechanically supported and sealed after installation. Although the dampers can be installed in any orientation, it is desirable to install them where the LED indicators on the damper actuators can be seen to verify they are opening and closing.

2) Damper Wiring

The dampers are factory set for Zone1 and Address 1.

The dampers are powered by 24VAC and require only 2.8VA when operating and only 1VA when holding.

A 40VA transformer can power up to 10 dampers.

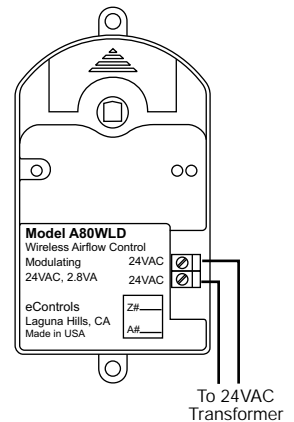

- ⚠ Solid green LED indicates open damper position.
- ⚠ Solid red LED indicates closed damper position.
- ⚠ Green and red LEDs blinking indicates damper is in a modulated position.
- ⚠ Power Failure - When power is restored, the damper will go to a fully open position and resume communication with the Remote Control. The Remote Control will automatically refresh the position of the dampers every 15 minutes to the last set airflow provided the Remote Control is powered and within 125' of the damper.

3) Installing Batteries

Remove the battery cover on the back of the remote control. Install two AAA batteries.

The remote control will immediately power up and default to Zone 1, Address 1 and 100% airflow.

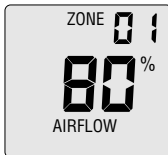

4) Testing Communication

Use the steps below to test the installation to insure the dampers are wired and set properly.

1. Turn power On to the actuator and observe the dampers go to the fully open position and the Green LED turns On.
2. Use the Down key on the Remote Control to set the Airflow to 0%. The damper goes to the closed position and the Red LED is On.
3. Use the Up key on the Remote Control to set the Airflow to 100%. The damper goes to the open position and the Green LED is On.

Changing the Damper Zone Number

The dampers are factory set for Zone1 and Address 1 and only need to be changed when the Remote Control is controlling airflow to multiple zones or spaces.

1. Press and hold the pushbutton switch and the green LED blinks once, pauses and blinks twice, pauses and blinks three times, etc. Release the switch after the number of blinks corresponding to the Zone number to be set.

The zone number can be reset at any time.

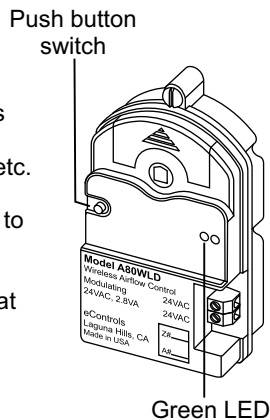

Changing the Damper Home Address

The dampers are factory set for Address 1 and only need to be changed when two or more installations are within 300' of one another.

1. Turn power Off to the actuator.
2. Press and hold the pushbutton switch while applying 24VAC power to the actuator. The red LED blinks once, pauses and blinks twice, pauses and blinks three times, etc. Release the switch after the number of blinks corresponding to the Address to be set.

The Address number can be reset at any time.

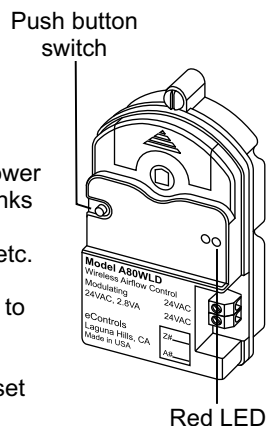

Setting Bypass

The R80DWL Damper actuator has a Close position limit that can be used to insure minimum airflow even when the damper has been set to 0% Airflow. The minimum Close Position can be set from about 50% closed to fully closed.

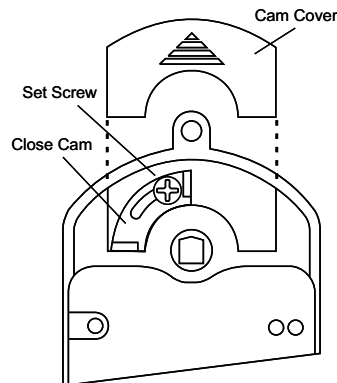

Set the damper to the fully open position by applying 24VAC to 24VAC terminals.

Loosen the set screw and rotate the Close Cam clockwise and **gently** tighten the set screw. With the cam set in the fully counter clockwise position, the damper will completely close. In the fully clockwise position, the damper will close to about 50% closed allowing some air to pass even when the user sets the damper to fully closed. Replace the cam cover.

Document Multiple Zone Locations

When a Remote Control is used to control airflow to multiple zones or spaces, record the zone locations below.

Zone 1	
Zone 2	
Zone 3	
Zone 4	
Zone 5	
Zone 6	
Zone 7	
Zone 8	

Home Address	1
--------------	---

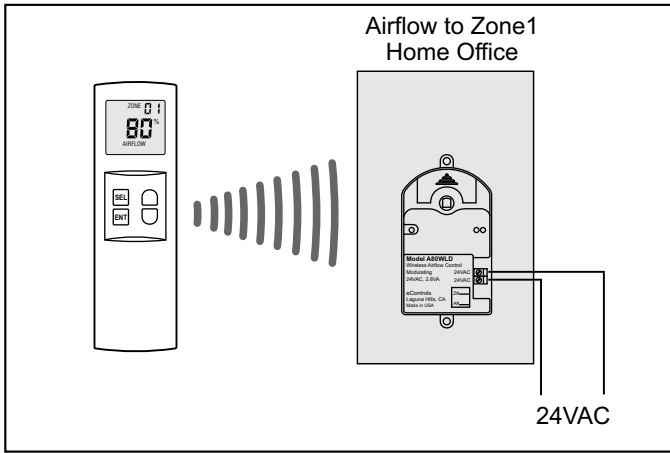

Remote controlling airflow to a home office using a single damper. Use as shipped as with Zone1, Home1.

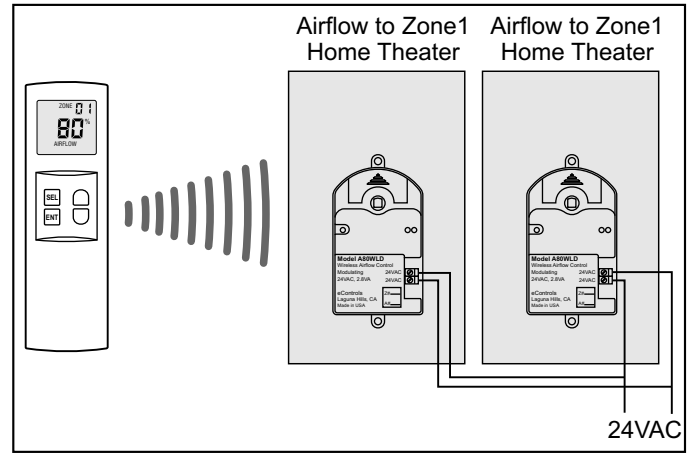

Remote controlling airflow to a home theater using two dampers. Use as shipped with as Zone1, Home1.

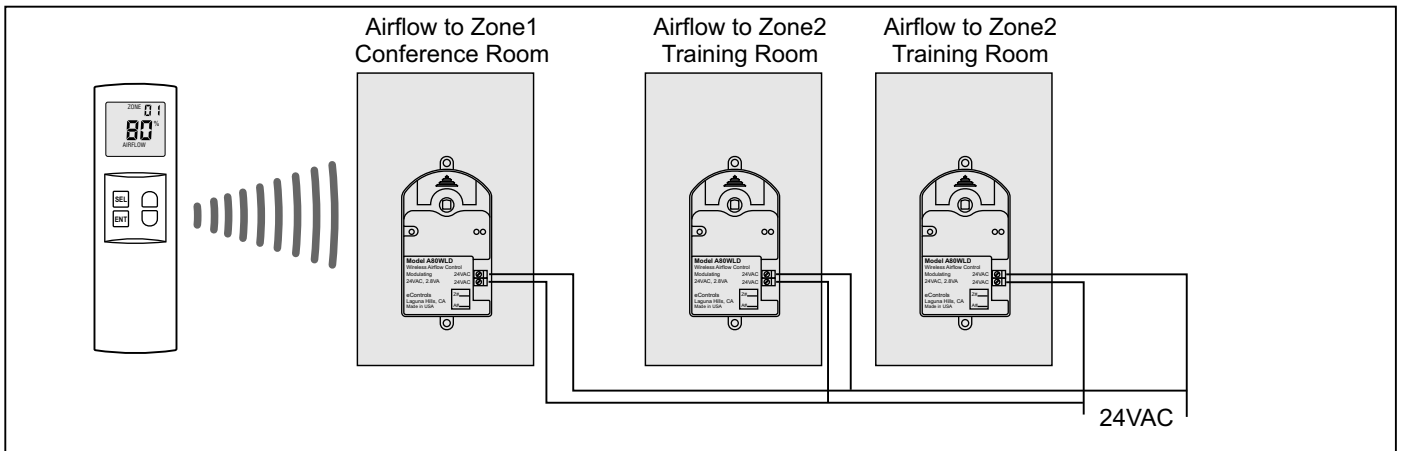

Remote controlling airflow to two zones or spaces. Zone1 damper uses factory set Zone1, Home1. Zone2 requires two dampers and must be set to Zone2 using the pushbutton switch on the actuator.

Limited 5-Year Warranty
 The 5-year warranty is limited to the repair or replacement of defective product due to parts failure or defective workmanship.

eControls
 26072 Merit Circle #110 / Laguna Hills, CA 92653
 949-916-0945 Fax 949-458-8502
 www.eControlsUSA.com