

## DESCRIPTION

The ZCDWLR 2-Zone Comfort Control works with any thermostat and automatically controls the distribution of heating and cooling to the upstairs and downstairs to keep the temperatures within 2 degrees to provide a uniformly comfortable home.

The ZCDWLR control is installed in the downstairs living zone, the wired temperature sensor is installed in the upstairs bedroom zone, the damper control is installed near the equipment and two modulating dampers are installed in the ducts controlling airflow to the upstairs and downstairs zones.

The ZCDWLR monitors the equipment for heating and cooling calls and monitors the upstairs and downstairs temperatures. If the temperatures differ by 2 degrees or more, the ZCDWLR automatically adjusts the modulating dampers every 2 minutes to distribute more heating or cooling to the zone that needs it for a uniformly comfortable home.

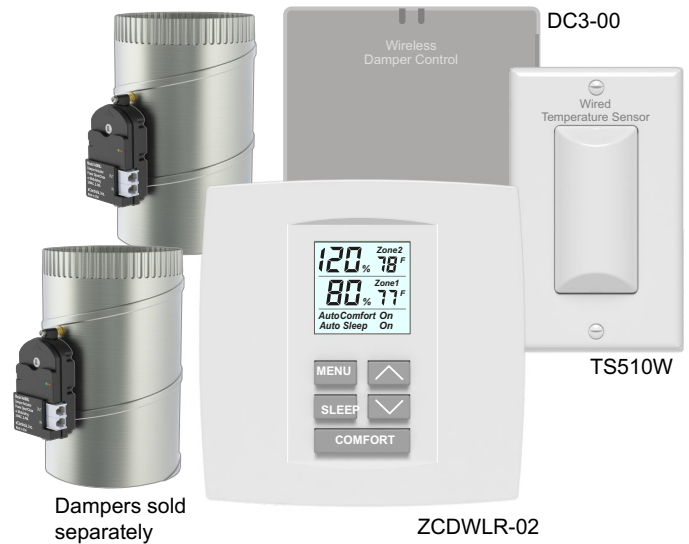

The ZCDWLR-K1 Kit includes a ZCDWLR-02 2-Zone Comfort Control, a TS510W Wired Temperature Sensor and a DC3-00 Wireless Damper Control. Dampers are sold separately.

## FEATURES

### AIRFLOW COMFORT SELECTION

#### Automatic Uniform Comfort

The ZCDWL monitors the upstairs and downstairs temperatures and automatically adjusts the distribution of heating and cooling to the upstairs and downstairs to keep the spaces within 2 degrees of each other. Factory default.

#### Upstairs Comfort Focus

More heating or cooling is directed upstairs and less to the unoccupied downstairs.

#### Downstairs Comfort Focus

More heating or cooling is directed downstairs and less to the unoccupied upstairs.

### NIGHTTIME COMFORT CONTROL

Automatically directs 30% more heating or cooling to the upstairs sleeping zone and 30% less to the unoccupied downstairs living zone. Factory set to Off.



### AIRFLOW LIMITS

40% to 160%.

### AIRFLOW ADJUSTMENT

The ZCDWLR makes a larger initial adjustment to distribution if the upstairs and downstairs temperatures differ greatly. After the initial adjustment, the ZCDWLR makes a 2% adjustment to distribution every 2 minutes.

### TEMPERATURE CALIBRATION OPTION

The ZCDWLR includes a temperature calibration option for calibrating the upstairs and downstairs temperatures. This is helpful if the thermostat is reading a bit differently than the ZCDWLR control. To access the option, press the **MENU** key until CA Zone1 or CA Zone2 is displayed. Use the  or  keys to make an adjustment.

### COMPATIBLE THERMOSTAT

Any smart, OEM or simple 24VAC thermostat.

### COMPATIBLE EQUIPMENT

Gas/Electric or Heat Pump equipment. ZCDWLR only monitors the equipment.

### COMPATIBLE MODULATING DAMPERS

Model R80CJ - Round, Plug&Play Damper  
Model RT80CJ - Rectangular, Plug&Play Damper.

### POWER

- The ZCDWLR operates on 24VAC using the R and C terminals at the thermostat or at the equipment.
- The DC3-00 operates on 24VAC using the R and C terminals at the equipment.

### WARRANTY

5-year warranty, limited to the repair or replacement of the product due to defective material or workmanship.

Installation  
Video



### INSTALLER QUICK TIP

The ZCDWLR 2-Zone Comfort Control and the DC3 Damper Control are prelinked and communicate wirelessly. When first powered up, the units will establish wireless communication automatically. Once linked, the Zone 2 temperature will be displayed, usually within 30-60 seconds.

# INSTALLATION

## WIRING DIAGRAM

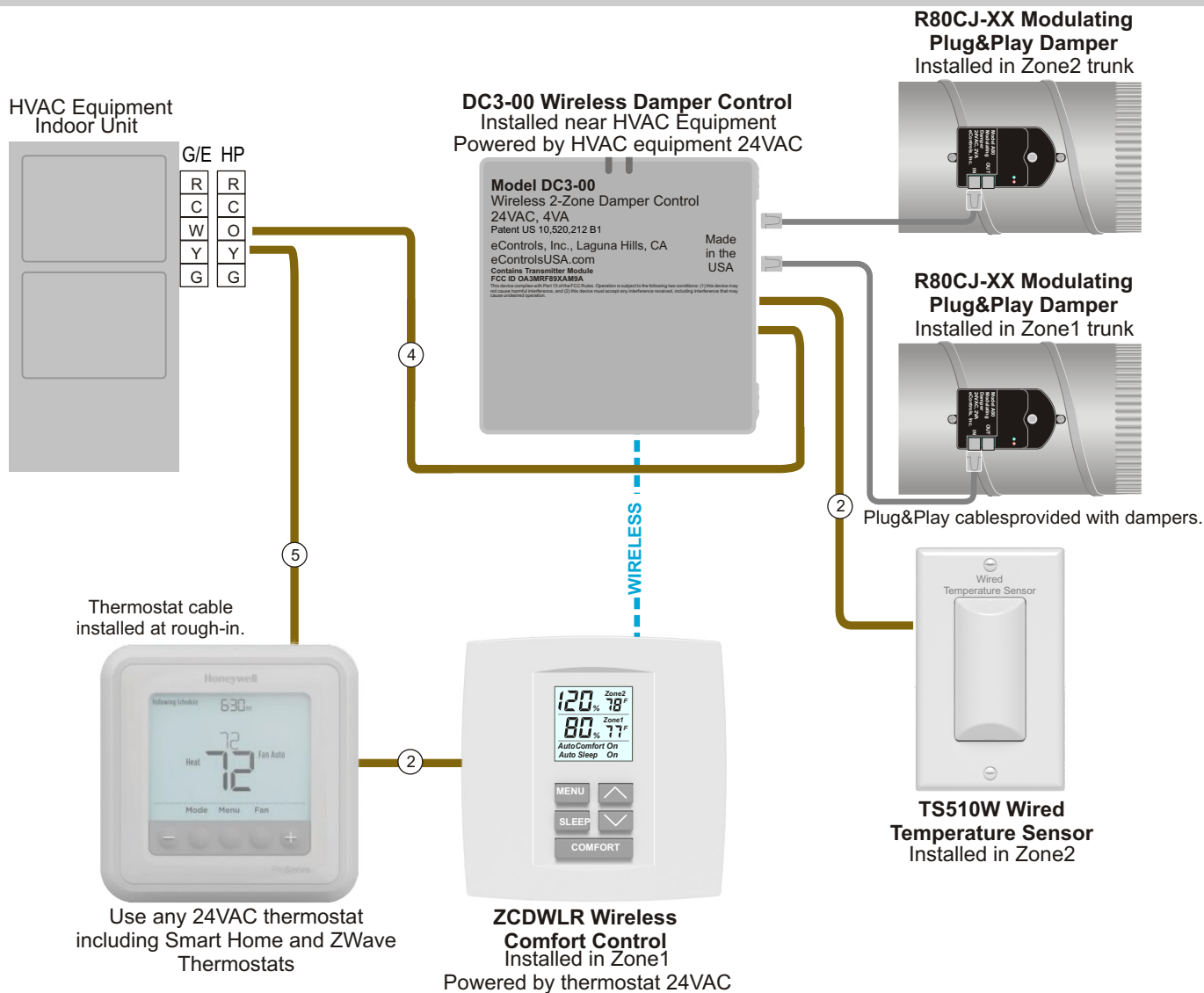

### CAUTIONS

- Before installing the ZCDWLR system, turn off all power to the HVAC system.
- Read and follow all instructions carefully.
- Read entire manual before installing products.
- Follow all local electrical codes during installation. All wiring must conform to local and national electrical codes.
- Use cautions when mounting components to surfaces that may have concealed wiring beneath the surface.
- When servicing products or accessing products, turn off all power to these items.

### INSTALLATION STEPS

1. Rough-In Wiring
2. Install DC3 Damper Control
3. Wire DC3 to Equipment
4. Install Dampers
5. Connect Dampers to DC3 Damper Control
6. Install and Wire Sensor
7. Install and Wire ZCDWLR 2-Zone Control
8. Power Equipment, Controls and Dampers
9. Set Options

### 1. ROUGH IN WIRING

Use 18 or 20 gage thermostat cable.

#### Rough-In Wiring - TS510W Temperature Sensor

The typical location for the TS510W Temperature Sensor is on an upstairs wall (Zone 2), about 5 feet off the floor, in a space that will best detect the temperature for the upstairs zone. The sensor fits in a standard single gang switch box or can be mounted directly to the wall using the hardware provided.

- Run a 2-conductor thermostat cable from the sensor location to the DC3-00 installed near the equipment.

#### Rough-In Wiring - ZCDWLR 2-Zone Comfort Control

The typical location for the ZCDWLR 2-Zone Comfort Control is on a downstairs wall (Zone 1) near the thermostat. The ZCDWLR can be powered either using the thermostat R and C terminals or using the equipment R and C terminals.

- **Powering using the thermostat R and C terminals.** Run a 2-conductor thermostat cable from the ZCDWLR Comfort Control location to the thermostat location.
- **Powering using the equipment R and C terminals.** Run a 2-conductor thermostat cable from the ZCDWLR Comfort Control location to the equipment.

# INSTALLATION

## 2. INSTALL DC3-00 DAMPER CONTROL

Remove the cover of the DC3 Damper Control by pressing the tabs in the area indicated to release the cover.

Mount the DC3 near the HVAC equipment using the hardware provided. Locate it on a wall, stud or roof truss. Do not install on a metal surface or near 120VAC lines as this may interfere with the wireless communication.

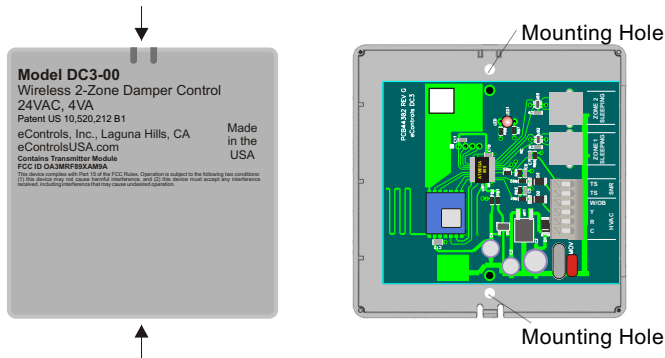

## 3. WIRE DC3-00 TO EQUIPMENT

The DC3-00 Damper Control is wired to the equipment for power using the R and C terminals and for monitoring the status of heating and cooling calls using the W/OB and Y terminals.

- Use 4-conductor, 18 or 20 gage thermostat cable to connect the DC3-00 Damper Control terminals W/OB, Y, R and C to gas electric equipment terminals W, Y, R and C or heat pump equipment terminals OB, Y, R and C.

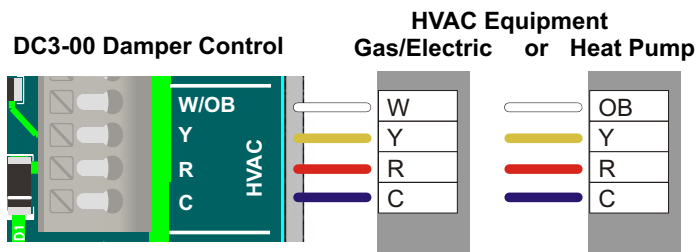

## 4. INSTALL DAMPERS

In a typical installation, Zone 1 is the downstairs living zone and Zone 2 is the upstairs sleeping zone. Install an R80CJ or RT80CJ damper in the trunk supplying air to Zone 1. Install a second R80CJ or RT80CJ damper in the trunk supplying air to Zone 2. Install so crimped end is in the direction of airflow. Each damper uses 2.4VA of power.

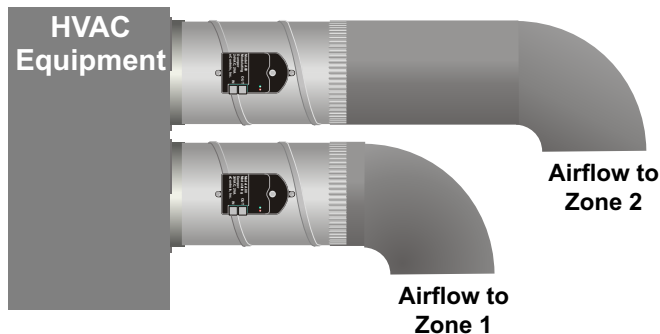

⚠ Ensure that damper installation does not cause obstruction to the damper blade.

## 5. CONNECT DAMPERS TO DC3-00 DAMPER CONTROL

Using one of the plug&play cables included with the dampers, plug one end of the cable into the "IN" connector on the Zone 1 damper actuator then plug the other end into the Zone 1 connector on the DC3-00 Damper Control. Using the other cable, plug one end of the cable into the "IN" connector on the Zone 2 damper actuator then plug the other end into the Zone 2 connector on the DC3-00 Damper Control.

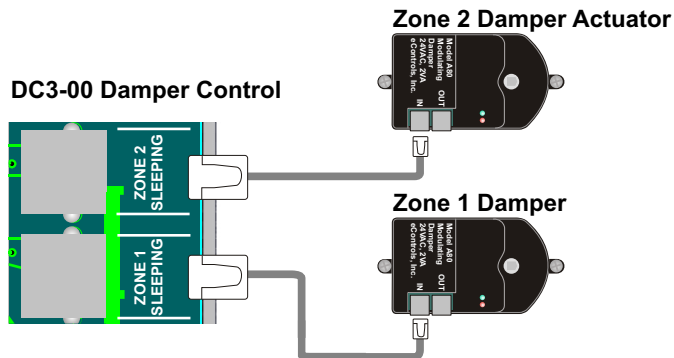

## 6. INSTALL and WIRE SENSOR

- At the DC3-00 Damper Control, connect the sensor wire installed during rough in to the two sensor terminals on the DC3-00 marked SNR.
- At the TS510W sensor, connect the sensor wire to the sensor by placing the wires between the brass washers and the printed circuit board. Hand tighten the screws.
- Install the sensor in a single gang box or directly to the wall using the hardware provided.

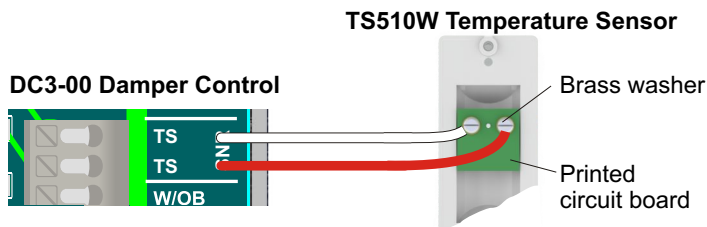

## 7. INSTALL and WIRE ZCDWLR 2-ZONE CONTROL

- Feed the ZCDWLR wire installed during rough in through the back of the ZCDWLR subbase. Attach the ZCDWLR subbase to the wall using the provided hardware.
- On the ZCDWLR subbase, connect one wire to the terminal marked R and connect the other wire to the terminal marked C.
- At the thermostat or at the equipment, connect the R wire from the ZCDWLR to the thermostat R terminal or the equipment R terminal. Connect the C wire from the ZCDWLR to the thermostat C terminal or the equipment C terminal.



# INSTALLATION

## 8. POWER CONTROLS AND DAMPERS

Apply power to the equipment. The ZCDWLR Control, DC3 Damper Control and Dampers should all be powered.



### INSTALLER OPTIONS

Option	Default	Range
Equipment Type	Gas/Electric	Gas/Electric or Heat Pump
Heat Pump Reversing Valve	Type o	Type o or Type B
ZCDWLR Location	Zone 1 Downstairs	Zone 1 Downstairs or Zone 2 Upstairs

To access the installer options, press the **MENU** key and **COMFORT** key at the same time to display the first option. Press the **MENU** key to advance through the options.

### OPTION 1 - EQUIPMENT TYPE

Defaults to Gas/Electric equipment.

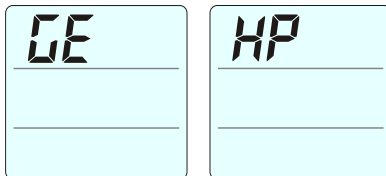

Pressing the  key selects GE (Gas/Electric). Pressing the  key selects HP (Heat Pump).

Press **MENU** to go to the next option.



### OPTION 2 - HEAT PUMP REVERSING VALVE TYPE

Only displayed if HP was selected. Defaults to type o.

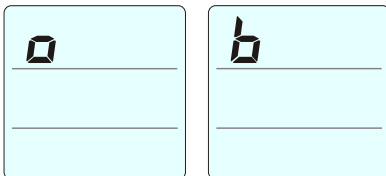

Pressing the  key selects o type. Pressing the  key selects B type.

Press **MENU** to go to the next option.



### OPTION 3 - ZCDWLR LOCATION

Defaults to Zone 1 Downstairs location. Use this option to change the ZCDWLR location if the ZCDWLR will be installed in Zone 2 (Upstairs) and the sensor will be installed in Zone 1 (Downstairs).

Pressing the  key selects downstairs location. Pressing the  key selects upstairs location.

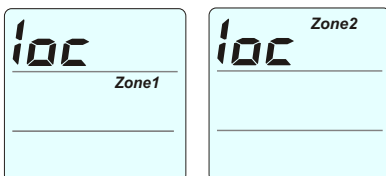

Press **MENU** to return to normal operation.

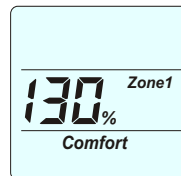

### TEST ZONE 1 (DOWNSTAIRS) AIRFLOW

Press the **COMFORT** key to select Zone 1 Comfort. The selection is saved when the backlight turns off.



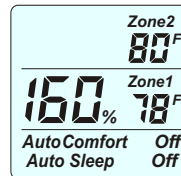

Press the  key to increase airflow to 160% in Zone 1. The setting is saved when the backlight turns off. You should measure or feel more airflow in Zone 1 and less in Zone 2. Press the  key to return airflow to the default of 130%.

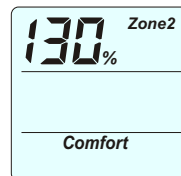

### TEST ZONE 2 (UPSTAIRS) AIRFLOW

Press the **COMFORT** key to select Zone 2 Comfort. The selection is saved when the backlight turns off.



Press the  key to increase airflow to 160% in Zone 2. The setting is saved when the backlight turns off. You should measure or feel more airflow in Zone 2 and less in Zone 1. Press the  key to return airflow to the default of 130%.

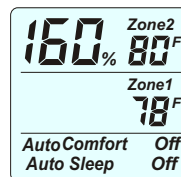

To return the ZCDWLR to the default of Auto Comfort On, press the **COMFORT** key to select Auto Comfort On. The selection is saved when the backlight turns off.

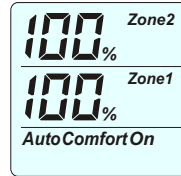

### TROUBLESHOOTING

#### Airflow appears to be reversed or not changing.

Make sure the connections for the upstairs and downstairs dampers are not reversed. Make sure the DC3 is powered by observing lit LED on the DC3. Make sure the dampers are powered by observing a green LED when the dampers are in a 100% open position.

#### Understanding Damper LEDs and Airflow

Airflow Displayed	Zone 1 Damper	Zone 2 Damper
100% Zone 2 100% Zone 1	Open Green LED	Open Green LED
More Airflow to Zone 1	Open Green LED	Partially Closed No LED
More Airflow to Zone 2	Partially Closed No LED	Open Green LED

#### No Display on ZCDWLR

Make sure the equipment and thermostat are powered in order to provide power to the ZCDWLR. Check the wiring.

#### Sensor Error

-- displayed where the Zone 2 temperature should be displayed indicates a sensor error. Check the sensor wiring.

#### nC Communication Error

nC indicates a loss of communication with the DC3 Damper Control. Check power and wiring to the DC3

## Limited 5-Year Warranty

The 5-year warranty is limited to the repair or replacement of defective product due to parts failure or defective workmanship.

# eControls

26072 Merit Circle #110 / Laguna Hills, CA 92653  
949-916-0945 Fax 949-458-8502 www.eControlsUSA.com